

A Course Material on
HUMAN RESOURCE MANAGEMENT



By

Ms.R.RENUKADEVI

ASSISTANT PROFESSOR

DEPARTMENT OF MANAGEMENT SCIENCE

SASURIE COLLEGE OF ENGINEERING

VIJAYAMANGALAM – 638 056

QUALITY CERTIFICATE

This is to certify that the e-course material

Subject Code : **BA7204**

Subject : **HUMAN RESOURCE MANAGEMENT**

Class : **I MBA**

being prepared by me and it meets the knowledge requirement of the university curriculum.

Signature of the Author

Name: R.Renukadevi

Designation: Assistant Professor

This is to certify that the course material being prepared by Ms.R.RENUKADEVI is of adequate quality. she has referred more than five books amount them minimum one is from abroad author.

Signature of HD

Name : K.Thulasivelu

SEAL :

CONTENTS

CHAPTER	TOPICS	PAGE NO
I	PERSPECTIVES IN HUMAN RESOURCE MANAGEMENT	7-36
	1.1.1 Definitions of HRM	
	1.1.2 Nature of HRM	
	1.1.3 Features of HRM	
	1.1.4 Scope of HRM	
	1.1.5 Objectives of HRM	
	1.1.6 Functions of HRM	
	1.2 Evolution of human resource management	
	1.3 Importance/Significance of human Factor	
	1.4 Challenges In HRM	
1.5 Inclusive Growth And Affirmative Action Of HR In An Organization		
1.6 Role Of Human Resource Manager		
1.7 Human Resource Policies		
1.8 Computer Applications In Human Resource Management		
1.9 Human Resource Accounting And Audit.		
II	THE CONCEPT OF BEST FIT EMPLOYEE	37-73
	2.1 Importance of Human resource planning	
	2.1.1 Definition of HRP	
	2.1.2 Nature of Human resource planning	
	2.1.3 Importance of Human resource planning	
	2.1.4 HRP Process	
	2.1.5 Requisites for successful HRP	
	2.1.6 Barriers to HRP	
	2.2 Internal and external sources	
	2.3 Recruitment	
2.3.1 Process of Recruitment		
2.3.2 Recruitment Policy		
2.3.3 Factor Affecting Recruitment		
2.3.4 Methods of Recruitment		
2.5 Selection		
2.5.1 Selection Procedure		
2.6 Induction		
2.6.1 The induction timetable		
2.6.2 The induction process		
2.7 Socialization Benefits		
2.7.1 Stages in socialization Process		
III	TRAINING AND EXECUTIVE DEVELOPMENT	73-100
	3.1 Types of Training Methods	
	3.1.1 Training And Development Objectives	
3.1.2 Benefits		
3.1.3 Need for Employee Training		
3.1.4 Importance		
3.2 Purpose		

III	3.3 Benefits	
	3.4 Resistance to training	
	3.5 Executive Development Programme 3.5.1 Factors Influencing Executive Development 3.5.2 Factors Influencing Executive Development 3.5.3 Process 3.5.4 The Process of Executive Development 3.5.5 Evaluation of Executive Development 3.5.6 Methods of Executive Development	
	3.6 Self Development	
	3.7 Knowledge Management 3.7.1 Dimensions 3.7.2 Strategies 3.7.3 KM Technologies	
IV	SUSTAINING EMPLOYEE INTEREST	101-115
	4.1 Compensation Plan 4.1.1 Compensation 4.1.2 Objectives of Compensation Planning 4.1.3 Factors Affecting Compensation Planning 4.1.4 Various Modes of Compensation	
	4.2 Reward 4.2.1 Objectives of Reward Management 4.2.2 Basic Types of Reward	
	4.3 Motivation 4.3.1 Motivation theories	
	4.4 Application of theories of Motivation	
	4.5 Career Management 4.5.1 Objective 4.5.2 Process	
	4.6 Development of Mentor 4.6.1 Requirements for effective mentor-protégé relationship	
V	PERFORMANCE EVALUATION AND CONTROL PROCES	116-129
	5.1 Method of Performance Evaluation 5.1.1 Designing a Performance Appraisal System 5.1.2 Performance Appraisal System Errors 5.1.3 Performance Appraisal Legal Considerations	
	5.2 Feedback 5.2.1 Performance Feedback 5.2.2 Features of Performance Feedback 5.2.3 Types of Performance Feedback 5.2.4 Process of Performance Feedback	
	5.3 Promotion 5.3.1 Definitions of Promotion 5.3.2 Types of Promotion	

	5.3.3 Basis of Promotion	
	5.4 Transfer 5.4.1 Types of Transfers	
	5.5 Separation	
	5.6 Implication of Job change	
	5.7 control Process	
	5.8 Grievances 5.8.1 Grievance may result from the following factors- 5.8.2 Objectives of Grievance Handling Procedure 5.8.3 Benefits of Grievance Handling Procedure 5.8.4 four stages of the machinery 5.8.5 Methods of Identifying Grievances 5.8.6 The following steps provide a measure of guidance to the manager dealing with grievances	
	QUESTION BANK	131-133
	UNIVERSITY QUESTIONS	134-151

BA7204**HUMAN RESOURCE MANAGEMENT****L T P C
3 0 0 3****UNIT I PERSPECTIVES IN HUMAN RESOURCE MANAGEMENT****5**

Evolution of human resource management – The importance of the human factor – Challenges – Inclusive growth and affirmative action -Role of human resource manager – Human resource policies – Computer applications in human resource management – Human resource accounting and audit.

UNIT II THE CONCEPT OF BEST FIT EMPLOYEE**8**

Importance of Human Resource Planning – Forecasting human resource requirement –matching supply and demand - Internal and External sources. Recruitment - Selection – induction – Socialization benefits.

UNIT III TRAINING AND EXECUTIVE DEVELOPMENT**10**

Types of training methods –purpose- benefits- resistance. Executive development programmes – Common practices - Benefits – Self development – Knowledge management.

UNIT IV SUSTAINING EMPLOYEE INTEREST**12**

Compensation plan – Reward – Motivation – Application of theories of motivation – Career management – Development of mentor – Protégé relationships.

UNIT V PERFORMANCE EVALUATION AND CONTROL PROCESS**10**

Method of performance evaluation – Feedback – Industry practices. Promotion, Demotion, Transfer and Separation – Implication of job change. The control process – Importance – Methods – Requirement of effective control systems grievances – Causes – Implications – Redressal methods.

TOTAL PERIODS: 45**TEXTBOOK**

1. Dessler Human Resource Management, Pearson Education Limited, 2007
2. Decenzo and Robbins, Human Resource Management, Wiley, 8th Edition, 2007.

REFERENCES

1. Luis R.Gomez-Mejia, David B.Balkin, Robert L Cardy. Managing Human Resource. PHI Learning. 2012
2. Bernadin , Human Resource Management ,Tata Mcgraw Hill ,8th edition 2012.
3. Wayne Cascio, Managing Human Resource, McGraw Hill, 2007.
4. Ivancevich, Human Resource Management, McGraw Hill 2012.
5. Uday Kumar Haldar, Juthika Sarkar. Human Resource management. Oxford. 2012

TOTAL: 45 PERIODS

CHAPTER I

PERSPECTIVES IN HUMAN RESOURCE MANAGEMENT

1.1 What is Human Resource Management?

HRM is the study of activities regarding people working in an organization. It is a managerial function that tries to match an organization's needs to the skills and abilities of its employees.

1.1.1 Definitions of HRM

Human resources management (HRM) is a management function concerned with hiring, motivating and maintaining people in an organization. It focuses on people in organizations. **Human resource management** is designing management systems to ensure that human talent is used effectively and efficiently to accomplish organizational goals.

HRM is the personnel function which is concerned with procurement, development, compensation, integration and maintenance of the personnel of an organization for the purpose of contributing towards the accomplishments of the organization's objectives. Therefore, personnel management is the planning, organizing, directing, and controlling of the performance of those operative functions (Edward B. Philippo).

According to the Invancevich and Glueck, "HRM is concerned with the most effective use of people to achieve organizational and individual goals. It is the way of managing people at work, so that they give their best to the organization".

According to Dessler (2008) the policies and practices involved in carrying out the "people" or human resource aspects of a management position, including recruiting, screening, training, rewarding, and appraising comprises of HRM.

1.1.2 Nature of HRM

HRM is a management function that helps manager's to recruit, select, train and develop members for an organization. HRM is concerned with people's dimension in organizations.

The following constitute the core of HRM

1. HRM Involves the Application of Management Functions and Principles. The functions and principles are applied to acquiring, developing, maintaining and providing remuneration to employees in organization.

2. Decision Relating to Employees must be Integrated. Decisions on different aspects of employees must be consistent with other human resource (HR) decisions.

3. Decisions Made Influence the Effectiveness of an Organization. Effectiveness of an organization will result in betterment of services to customers in the form of high quality products supplied at reasonable costs.

4. HRM Functions are not Confined to Business Establishments Only but applicable to non business organizations such as education, health care, recreation and like. HRM refers to a set of programmes, functions and activities designed and carried out in order to maximize both employee as well as organizational effectiveness.

1.1.3 Features of HRM or characteristics or nature

1. HRM involves management functions like planning, organizing, directing and controlling
2. It involves procurement, development, maintenance of human resource
3. It helps to achieve individual, organizational and social objectives
4. HRM is a mighty disciplinary subject. It includes the study of management psychology communication, economics and sociology.
5. It involves team spirit and team work.

1.1.4 Significance/importance/need of HRM

HRM becomes significant for business organization due to the following reasons.

1. Objective :-
HRM helps a company to achieve its objective from time to time by creating a positive attitude among workers. Reducing wastage and making maximum use of resources etc.
2. Facilitates professional growth :-
Due to proper HR policies employees are trained well and this takes them ready for future promotions. Their talent can be utilized not only in the company in which they are currently working but also in other companies which the employees may join in the future.
3. Better relations between union and management :-
Healthy HRM practices can help the organization to maintain co-ordinal relationship with the unions. Union members start realizing that the company is also interested in the workers and will not go against them therefore chances of going on strike are greatly reduced.
4. Helps an individual to work in a team/group :-
Effective HR practices teach individuals team work and adjustment. The individuals are now very comfortable while working in team thus team work improves.
5. Identifies person for the future :-
Since employees are constantly trained, they are ready to meet the job requirements. The company is also able to identify potential employees who can be promoted in the future for the top level jobs. Thus one of the advantages of HRM is sparing people for the future.
6. Allocating the jobs to the right person :-
If proper recruitment and selection methods are followed, the company will be able to select the right people for the right job. When this happens the number of people leaving the job will reduce as they will be satisfied with their job leading to decrease in labour turnover.

7. Improves the economy:-

Effective HR practices lead to higher profits and better performance by companies due to this the company achieves a chance to enter into new business and start new ventures thus industrial development increases and the economy improves.

Scope of HRM

The major HRM activities include HR planning, job analysis, job design, employee hiring, employee and executive remuneration, employee motivation, employee maintenance, industrial relations and prospects of HRM.

The scope of Human Resources Management extends to:

- All the decisions, strategies, factors, principles, operations, practices, functions, activities and methods related to the management of people as employees in any type of organization.
- All the dimensions related to people in their employment relationships, and all the dynamics that flow from it.

The scope of HRM is really vast. All major activities in the working life of a worker – from the time of his or her entry into an organization until he or she leaves it comes under the purview of HRM. American Society for Training and Development (ASTD) conducted fairly an exhaustive study in this field and identified nine broad areas of activities of HRM.

These are given below:

- Human Resource Planning
- Design of the Organization and Job
- Selection and Staffing
- Training and Development
- Organizational Development
- Compensation and Benefits
- Employee Assistance
- Union/Labour Relations
- Personnel Research and Information System

a) Human Resource Planning: The objective of HR Planning is to ensure that the organization has the right types of persons at the right time at the right place. It prepares human resources inventory with a view to assess present and future needs, availability and possible shortages in human resource.

Thereupon, HR Planning forecast demand and supplies and identify sources of selection. HR Planning develops strategies both long-term and short-term, to meet the man-power requirement.

b) Design of Organization and Job:

This is the task of laying down organization structure, authority, relationship and responsibilities. This will also mean definition of work contents for each position in the organization. This is done by “job description”. Another important step is “Job specification. Job specification identifies the attributes of persons who will be most suitable for each job which is defined by job description.

c) Selection and Staffing:

This is the process of recruitment and selection of staff. This involves matching people and their expectations with which the job specifications and career path available within the organization.

d) Training and Development: This involves an organized attempt to find out training needs of the individuals to meet the knowledge and skill which is needed not only to perform current job but also to fulfil the future needs of the organization.

e) Organizational Development: This is an important aspect whereby “Synergetic effect” is generated in an organization i.e. healthy interpersonal and inter-group relationship within the organization.

f) Compensation and Benefits: This is the area of wages and salaries administration where wages and compensations are fixed scientifically to meet fairness and equity criteria. In addition labour welfare measures are involved which include benefits and services.

g) Employee Assistance: Each employee is unique in character, personality, expectation and temperament. By and large each one of them faces problems everyday. Some are personal some are official. In their case he or she remains worried. Such worries must be removed to make him or her more productive and happy.

h) Union-Labour Relations: Healthy Industrial and Labour relations are very important for enhancing peace and productivity in an organization. This is one of the areas of HRM.

i) Personnel Research and Information System: Knowledge on behavioral science and industrial psychology throws better insight into the workers expectations, aspirations and behaviour. Advancement of technology of product and production methods have created working environment which are much different from the past. Globalization of economy has increased competition many fold. Science of ergonomics gives better ideas of doing a work more conveniently by an employee. Thus, continuous research in HR areas is an unavoidable requirement. It must also take special care for improving exchange of information through effective communication systems on a continuous basis especially on moral and motivation.

Objectives of HRM

The primary objective of HRM is to ensure the availability of competent and willing workforce to an organization. The specific objectives include the following:

- 1) Human capital: assisting the organization in obtaining the right number and types of employees to fulfill its strategic and operational goals.
- 2) Developing organizational climate: helping to create a climate in which employees are encouraged to develop and utilize their skills to the fullest and to employ the skills and abilities of the workforce efficiently.
- 3) Helping to maintain performance standards and increase productivity through effective job design: providing adequate orientation, training and development; providing performance-related feedback; and ensuring effective two-way communication.
- 4) Helping to establish and maintain a harmonious employer/employee relationship
- 5) Helping to create and maintain a safe and healthy work environment
- 6) Developing programs to meet the economic, psychological, and social needs of the employees and helping the organization to retain the productive employees
- 7) Ensuring that the organization is in compliance with provincial/territorial and federal laws affecting the workplace (such as human rights, employment equity, occupational health and safety, employment standards, and labour relations legislation). To help the organization to reach its goals
- 8) To provide organization with well-trained and well-motivated employees
- 9) To increase the employees satisfaction and self-actualization
- 10) To develop and maintain the quality of work life
- 11) To communicate HR policies to all employees.

12) To help maintain ethical polices and behavior.

1.1.5 Objectives of HRM

1) Societal Objectives: seek to ensure that the organization becomes socially responsible to the needs and challenges of the society while minimizing the negative impact of such demands upon the organization. The failure of the organizations to use their resources for the society's benefit in ethical ways may lead to restriction.

2) Organizational Objectives: it recognizes the role of HRM in bringing about organizational effectiveness. It makes sure that HRM is not a standalone department, but rather a means to assist the organization with its primary objectives. The HR department exists to serve the rest of the organization.

3) Functional Objectives: is to maintain the department's contribution at a level appropriate to the organization's needs. Human resources are to be adjusted to suit the organization's demands. The department's value should not become too expensive at the cost of the organization it serves.

4) Personnel Objectives: it is to assist employees in achieving their personal goals, at least as far as these goals enhance the individual's contribution to the organization. Personal objectives of employees must be met if they are to be maintained, retained and motivated. Otherwise employee performance and satisfaction may decline giving rise to employee turnover.

Functions of HRM

Human Resources management has an important role to play in equipping organizations to meet the challenges of an expanding and increasingly competitive sector. Increase in staff numbers, contractual diversification and changes in demographic profile which compel the HR managers to reconfigure the role and significance of human resources management. The functions are responsive to current staffing needs, but can be proactive in reshaping organizational objectives. All the functions of HRM are correlated with the core objectives of HRM (Table 1.1). For example personal objectives is sought to be realized through functions like remuneration, assessment etc.

1.1.6 Functions of HRM

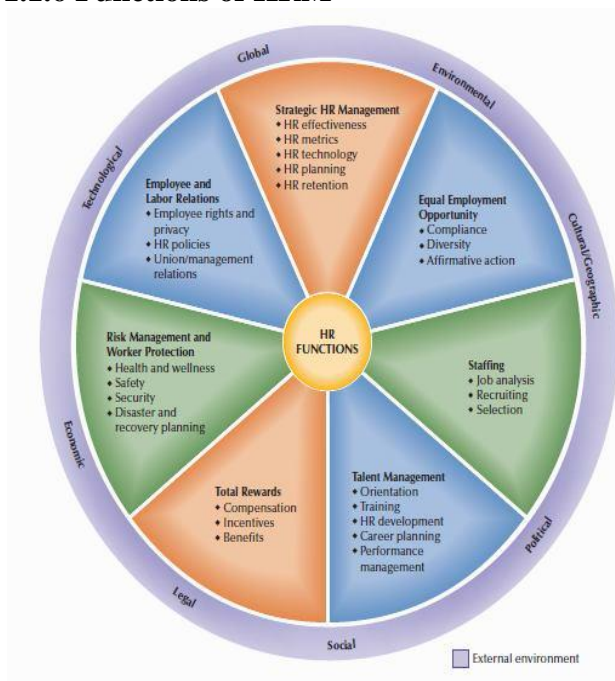

Strategic HR Management:

As a part of maintaining organizational competitiveness, strategic planning for HR effectiveness can be increased through the use of HR metrics and HR technology. Human resource planning (HRP) function determine the number and type of employees needed to accomplish organizational goals. HRP includes creating venture teams with a balanced skill-mix, recruiting the right people, and voluntary team assignment. This function analyzes and determines personnel needs in order to create effective innovation teams. The basic HRP strategy is staffing and employee development.

Equal Employment Opportunity: Compliance with equal employment opportunity (EEO) laws and regulations affects all other HR activities.

Staffing: The aim of staffing is to provide a sufficient supply of qualified individuals to fill jobs in an organization. Job analysis, recruitment and selection are the main functions under staffing. Workers job design and job analysis laid the foundation for staffing by identifying what diverse people do in their jobs and how they are affected by them.

Job analysis is the process of describing the nature of a job and specifying the human requirements such as knowledge, skills, and experience needed to perform the job. The end result of job analysis is job description. Job description spells out work duties and activities of employees. Through HR planning, managers anticipate the future supply of and demand for employees and the nature of workforce issues, including the retention of employees. So HRP precedes the actual selection of people for organization.

These factors are used when recruiting applicants for job openings. The selection process is concerned with choosing qualified individuals to fill those jobs. In the selection function, the most qualified applicants are selected for hiring from among the applicants based on the extent to which their abilities and skills are matching with the job.

Talent Management and Development: Beginning with the orientation of new employees, talent management and development includes different types of training. Orientation is the first step towards helping a new employee to adjust himself to the new job and the employer. It is a method to acquaint new employees with particular aspects of their new job, including pay and benefit programmes, working hours and company rules and expectations. Training and Development programs provide useful means of assuring that the employees are capable of performing their jobs at acceptable levels and also more than that. All the organizations provide training for new and in experienced employee. In addition, organization often provide both on the job and off the job training programmes for those employees whose jobs are undergoing change.

Likewise, HR development and succession planning of employees and managers is necessary to prepare for future challenges. Career planning has developed as result of the desire of many employees to grow in their jobs and to advance in their career. Career planning activities include assessing an individual employee's potential for growth and advancement in the organization. Performance appraisal includes encouraging risk taking, demanding innovation, generating or adopting new tasks, peer evaluation, frequent evaluations, and auditing innovation processes.

This function monitors employee performance to ensure that it is at acceptable levels. This strategy appraises individual and team performance so that there is a link between individual innovativeness and company profitability. Which tasks should be appraised and who should assess employees' performance are also taken into account.

Total Rewards: Compensation in the form of pay, incentives and benefits are the rewards given to the employees for performing organizational work. Compensation management is the method for determining how much employees should be paid for performing certain jobs.

Compensation affects staffing in that people are generally attracted to organizations offering a higher level of pay in exchange for the work performed. To be competitive, employers develop and refine their basic compensation systems and may use variable pay programs such as incentive rewards, promotion from within the team, recognition rewards, balancing team and individual rewards etc.

This function uses rewards to motivate personnel to achieve an organization's goals of productivity, innovation and profitability. Compensation is also related to employee development in that it provides an important incentive in motivating employees to higher levels of job performance to higher paying jobs in the organization.

Benefits are another form of compensation to employees other than direct pay for the work performed. Benefits include both legally required items and those offered at employer's discretion. Benefits are primarily related to the area of employee maintenance as they provide for many basic employee needs.

Risk Management and Worker Protection: HRM addresses various workplace risks to ensure protection of workers by meeting legal requirements and being more responsive to concerns for workplace health and safety along with disaster and recovery planning.

Employee and Labor Relations: The relationship between managers and their employees must be handled legally and effectively. Employer and employee rights must be addressed. It is important to develop, communicate, and update HR policies and procedures so that managers and employees alike know what is expected. In some organizations, union/management relations must be addressed as well.

The term labour relation refers to the interaction with employees who are represented by a trade union. Unions are organization of employees who join together to obtain more voice in decisions affecting wages, benefits, working conditions and other aspects of employment. With regard to labour relations the major function of HR personnel includes negotiating with the unions regarding wages, service conditions and resolving disputes and grievances.

1.2 Evolution of HRM

The evolution of HRM can be traced back to Kautilya Artha Shastra where he recommends that government must take active interest in public and private enterprise. He says that government must provide a proper procedure for regulating employee and employee relation

In the medieval times there were examples of kings like Allaudin Khilji who regulated the market and charged fixed prices and provided fixed salaries to their people. This was done to fight inflation and provide a decent standard of living

During the pre independence period of 1920 the trade union emerged. Many authors who have given the history of HRM say that HRM started because of trade union

and the First World War.

The Royal commission in 1931 recommended the appointment of a labour welfare officer to look into the grievances of workers. The factory act of 1942 made it compulsory to appoint a labour welfare officer if the factory had 500 or more than 500 workers.

The international institute of personnel management and national institute of labour management were set up to look into problems faced by workers to provide solutions to them. The Second World War created awareness regarding workers rights and 1940's to 1960's saw the introduction of new technology to help workers.

The 1960's extended the scope of human resource beyond welfare. Now it was a combination of welfare, industrial relation, administration together it was called personnel management. With the second 5 year plan, heavy industries started and professional management became important. In the 70's the focus was on efficiency of labour while in the 80's the focus was on new technology, making it necessary for new rules and regulations. In the 90's the emphasis was on human values and development of people and with liberalization and changing type of working people became more and more important thereby leading to HRM which is an advancement of personnel management.

1.3 Importance of the human factor

- Proper utilization of other resources
 - Help transform lifeless factors of production into useful products
- Capable of enlargement
 - produce extraordinary things when inspired
 - Can help organisation achieve results quickly, efficiently & effectively.
- The secret of their success is *“The way they treat their employees”* - Sony
- Nestle CEO *“Every single person in the organization should ask himself or herself – is there anything I can do to add a little more value to our organization”*
- *“How important are people treated in the Organization.”*
- Organization – acquires the services from the Employees, Develop their Skills and motivate them to achieve the organization objectives.
- HR - Productivity , Quality Work Life & Profit.
- *“The Enterprise is People” , “Organization need people and People need Organization.”*

IMPORTANCE OF HUMAN RESOURCE MANAGEMENT

The importance of human factor can be discussed as follows:

a) Social Significance:

Proper management of personnel, enhances their dignity by satisfying their social needs. This it does by i) maintaining a balance between the jobs available and the jobseekers, according to the qualifications and needs; ii) providing suitable and most productive employment, which

might bring them psychological satisfaction; iii) making maximum utilization of the resource in an effective manner and paying the employee a reasonable compensation in proportion to the contribution made by him; iv) eliminating waste or improper use of human resource, through conservation of their normal energy and health; and v) by helping people make their own decisions, that are in their interests.

b) Professional Significance:

By providing a healthy working environment it promotes teamwork in the employees. This it does by i) maintaining the dignity of the employee as a 'human-being'; ii) providing maximum opportunities for personal development; iii) providing healthy relationship between different work groups so that work is effectively performed; iv) improving the employees' working skill and capacity; v) correcting the errors of wrong postings and proper reallocation work.

c) Significance for Individual Enterprise:

It can help the organisation in accomplishing its goals by: i) creating right attitude among the employees through effective motivation; ii) utilizing effectively the available human resources; and iii) securing willing co-operation of the employees for achieving goals of the enterprise and fulfilling their own social and other psychological needs of recognition, love, affection, belongingness, esteem and self-actualisation.

Dynamic and growth-oriented organisations do require effective management of people in a fast-changing environment. Organisations flourish only through the efforts and competencies of their human resources. Employee capabilities must continuously be acquired, sharpened and used. Any organisation will have proper human resource management i) to improve the capabilities of an individual; ii) to develop team spirit of an individual and the department; and iii) to obtain necessary cooperation from the employees to promote organisational effectiveness.

It is the human resource, which is of paramount importance in the success of any organisation, because most of the problems in organisational settings are human and social rather than physical, technical or economic. Failure to reorganize this fact causes immense loss to the nation, enterprise and the individual. In the words of Oliver Sheldon, "No industry can be rendered efficient so long as the basic fact remain unrecognized that it is principally human. It is not a mass of machines and technical processes, but a body of men. It is not a complex matter, but a complex of humanity. It fulfills its function not by virtue of some impersonal force, but a

human energy. Its body is not an intricate maze of mechanical devices but a magnified nervous system”.

‘People at work’ comprise a large number of individuals of different sex, age, socio-religious group and different educational or literacy standards. These individuals in the work place exhibit not only similar behaviour patterns and characteristics to a certain degree, but they also show dissimilarity. Each individual who works has his own set of needs, drives, goals and experiences. Each has his own physical and psychological traits. Each human being is not only a product of his biological inheritance but also a result of interactions with his environment. Family relationships, religious influences, racial or caste backgrounds, educational accomplishment, the application of technological innovations, and many other environmental-experimental influences affect the individual as he works.

People come to work with certain specific motives to earn money, to get employment, to have better prospect in future, to be treated as a human being while at the place of work. They sell their labour for reasonable wage / salary and other benefits. It is these people who provide the knowledge and much of the energy through which organisational objectives are accomplished.

The management must, therefore, be aware not only of the organisational but also employee needs. None of these can be ignored

1.4 CHALLENGES IN HRM:

The HR Managers of today may find it difficult because of the rapidly changing business environment and therefore they should update their knowledge and skills by looking at the organization’s need and objectives.

1. **Managing the Vision:** Vision of the organization provides the direction to business strategy and helps managers to evaluate management practices and make decisions. So vision management becomes the integral part of the process of Man management in times to come .
2. **Internal Environment:** Creating an environment which is responsive to external changes, providing satisfaction to the employees and sustaining through culture and systems is a challenging task.
3. **Changing Industrial Relations:** Both the workers and managers have to be managed by the same HRM Philosophy and this is going to be a difficult task for the managers of tomorrow.
4. **Building Organizational Capability:** Even in the adverse circumstances the employees have to be made to live in psychological state of readiness to continually change.
5. **Job Design and Organization Structure:** Instead of depending on foreign concepts we need to focus on understanding the job, technology and the people involved in carrying out the tasks.

6. **Managing the Large Work Force:** Management of large workforce poses the biggest problem as the workers are conscious of their rights.
 8. **Employee Satisfaction:** Managers should be aware of techniques to motivate their employees so that their higher level needs can be satisfied.
 9. **Modern Technology:** There will be unemployment due to modern technology and this could be corrected by assessing manpower needs and finding alternate employment.
 10. **Computerized Information System:** This is revolutionary in managerial decision making and is having impact on coordination in the organization.
 11. **Managing Human Resource Relations:** As the workforce comprises of both educated and uneducated, managing the relations will be of great challenge. One of the challenges HR managers face is **issues of up gradation** of the skill set through training and development in the face of high attrition. Indian companies are recognizing their responsibilities to enhance the employee's opportunity to develop skills and abilities for full performance within the position and for career advancement.
-

What is affirmative action?

It is a program or policy of a company that aims to eliminate discrimination by providing equal opportunities and improving his /her profession. (education)

Affirmative action refers to policies that take factors including "race, color, religion, sex, or national origin" into consideration in order to benefit an underrepresented group, usually as a means to counter the effects of a history of discrimination.

Examples of affirmative action

- Recruit a diverse manpower
- Generate amiable work environment
- Training and counselling
- Disciplinary action against discrimination of any kind

Purpose



What is Inclusive growth?

Inclusive growth approach takes a longer term perspective as the focus is on productive employment

Examples

More Productive jobs will be created

Economic opportunity expanded for all

- Direct income redistribution
- Increasing incomes for excluded groups

1.5 INCLUSIVE GROWTH AND AFFIRMATIVE ACTION OF HR IN AN ORGANISATION

- Affirmative action should provide consistent, fair and ethical leadership to meet present and future HR challenges.

NEW TRENDS IN HUMAN RESOURCE MANAGEMENT

- Attitude Surveys
- Better Communication Channels
- Change in the Work-Life
- Job Redesign
- Job Enlargement
- New approaches to compensation and rewards
- Career Planning
- Performance Appraisal
- Decentralisation
- Breaking down the hierarchical structure
- Facilitating Empowerment

- Initiating and facilitating process of change
- Enlarging the knowledge base
- Developing team spirit
- Facilitating the employees desires of self-actualisation.

1.6 Role of HRM

The role of HRM is to plan, develop and administer policies and programs designed to make optimum use of an organizations human resources. It is that part of management which is concerned with the people at work and with their relationship within enterprises. Its objectives are:

- (a) Effective utilization of human resources,
- (b) Desirable working relationships among all members of the organizations, and
- (c) Maximum individual development.

Human resources function as primarily administrative and professional. HR staff focused on administering benefits and other payroll and operational functions and didn't think of themselves as playing a part in the firm's overall strategy.

HR professionals have an all encompassing role. They are required to have a thorough knowledge of the organization and its intricacies and complexities.

The ultimate goal of every HR person should be to develop a linkage between the employee and organization because employee's commitment to the organization is crucial.

The first and foremost role of HR personnel is to impart continuous education to the employees about the changes and challenges facing the country in general and their organization in particular. The employees should know about the balance sheet of the company, sales progress, and diversification of plans, share price movements, turnover and other details about the company. The HR professionals should impart such knowledge to all employees through small booklets, video films and lectures.

The primary responsibilities of Human Resource managers are:

- To develop a thorough knowledge of corporate culture, plans and policies.
- To act as an internal change agent and consultant
- To initiate change and act as an expert and facilitator
- To actively involve in company's strategy formulation
- To keep communication line open between the HRD function and individuals and groups both within and outside the organization\
- To identify and evolve HRD strategies in consonance with overall business strategy.
- To facilitate the development of various organizational teams and their working relationship with other teams and individuals.
- To try and relate people and work so that the organization objectives are achieved efficiently and effectively.
- To diagnose problems and determine appropriate solution particularly in the human resource areas.
- To provide co-ordination and support services for the delivery of HRD programmes and services
- To evaluate the impact of an HRD intervention or to conduct research so as to identify, develop or test how HRD In general has improved individual and organizational performance.

According to Dave Ulrich HR play's four key roles.

- 1. Strategic Partner Role**-Turning strategy into results by building organizations that create value;
- 2. Change Agent Role**- making change happen, and in particular, help it happen fast
- 3. Employees Champion Role**—managing the talent or the intellectual capital within a firm
- 4. Administrative Role**—Trying to get things to happen better, faster and cheaper.

The role HR in organizations has undergone an extensive change and many organizations have gradually oriented themselves from the traditional personnel management to a human resources management approach.

The basic approach of HRM is to perceive the organization as a whole. Its emphasis is not only on production and productivity but also on the quality of life. It seeks to achieve the paramount development of human resources and the utmost possible socio-economic development.

Current Classification of HR roles

According to R.L Mathis and J. H. Jackson (2010) several roles can be fulfilled by HR management. The nature and extent of these roles depend on both what upper management wants HR management to do and what competencies the HR staff have demonstrated. Three roles are typically identified for HR.

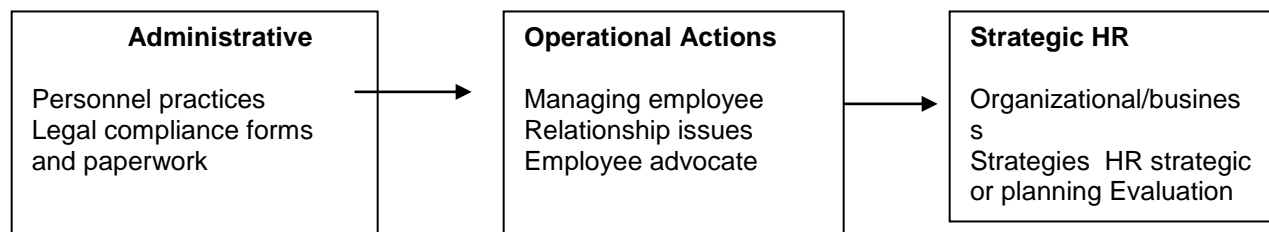

1. Administrative Role of HR

The administrative role of HR management has been heavily oriented to administration and recordkeeping including essential legal paperwork and policy implementation. Major changes have happened in the administrative role of HR during the recent years. Two major shifts driving the transformation of the administrative role are: Greater use of technology and Outsourcing.

Technology has been widely used to improve the administrative efficiency of HR and the responsiveness of HR to employees and managers, more HR functions are becoming available electronically or are being done on the Internet using Web-based technology. Technology is being used in most HR activities, from employment applications and employee benefits enrollments to e-learning using Internet-based resources.

Increasingly, many HR administrative functions are being outsourced to vendors. This outsourcing of HR administrative activities has grown dramatically in HR areas such as employee assistance (counseling), retirement planning, benefits administration, payroll services, and outplacement services.

2. Operational and Employee Advocate Role for HR

HR managers manage most HR activities in line with the strategies and operations that have been identified by management and serves as employee “champion” for employee issues and concerns.

HR often has been viewed as the “employee advocate” in organizations. They act as the voice for employee

concerns, and spend considerable time on HR “crisis management,” dealing with employee problems that are both work-related and not work-related. Employee advocacy helps to ensure fair and equitable treatment for employees regardless of personal background or circumstances.

Sometimes the HR’s advocate role may create conflict with operating managers. However, without the HR advocate role, employers could face even more lawsuits and regulatory complaints than they do now.

The operational role requires HR professionals to cooperate with various departmental and operating managers and supervisors in order to identify and implement needed programs and policies in the organization. Operational activities are tactical in nature. Compliance with equal employment opportunity and other laws is ensured, employment applications are processed, current openings are filled through interviews, supervisors are trained, safety problems are resolved, and wage and benefit questions are answered. For carrying out these activities HR manager matches HR activities with the strategies of the organization.

3. Strategic Role for HR

The administrative role traditionally has been the dominant role for HR. However, as Figure 1.4 indicates that a broader transformation in HR is needed so that significantly less HR time and fewer HR staffs are used just for clerical work.

Differences between the operational and strategic roles exist in a number of HR areas. The strategic HR role means that HR professionals are proactive in addressing business realities and focusing on future business needs, such as strategic planning, compensation strategies, the performance of HR, and measuring its results. However, in some organizations, HR often does not play a key role in formulating the strategies for the organization as a whole; instead it merely carries them out through HR activities.

Many executives, managers, and HR professionals are increasingly seeing the need for HR management to become a greater strategic contributor to the “business” success of organizations. HR should be responsible for knowing what the true cost of human capital is for an employer. For example, it may cost two times key employees’ annual salaries to replace them if they leave. Turnover can be controlled through HR activities, and if it is successful in saving the company money with good retention and talent management strategies, those may be important contributions to the bottom line of organizational performance.

The role of HR as a *strategic business partner* is often described as “having a seat at the table,” and contributing to the strategic directions and success of the organization. That means HR is involved in *devising* strategy in addition to *implementing* strategy. Part of HR’s contribution is to have financial expertise and to produce financial results, not just to boost employee morale or administrative efficiencies. Therefore, a significant concern for chief financial officers (CFOs) is whether HR executives are equipped to help them to plan and meet financial requirements.

However, even though this strategic role of HR is recognized, many organizations still need to make significant progress toward fulfilling it. Some examples of areas where strategic contributions can be made by HR are:

- Evaluating mergers and acquisitions for organizational “compatibility,” structural changes, and staffing needs
- Conducting workforce planning to anticipate the retirement of employees at all levels and identify

- workforce expansion in organizational strategic plans
- Leading site selection efforts for new facilities or transferring operations to international outsourcing
 - locations based on workforce needs
 - Instituting HR management systems to reduce administrative time, equipment, and staff by using HR technology
 - Working with executives to develop a revised sales
 - compensation and incentives plan as new products

It is the era when for the competitive triumph of the organization there is a need to involve HRM significantly in an integrated manner, which demands such capabilities from the HR specialists.

The role of HR shifted from a facilitator to a functional peer with competencies in other functions, and is acknowledged as an equal partner by others. The HR is motivated to contribute to organizational objectives of profitability and customer satisfaction, and is seen as a vehicle for realization of quality development. The department has a responsibility for monitoring employee satisfaction, since it is seen as substitute to customer satisfaction.

According to McKinsey's 7-S framework model HR plays the role of a catalyst for the organization. According to this framework, effective organizational change is a complex relationship between seven S's. HRM is a total matching process between the three Hard S's (Strategy, Structure and Systems) and the four Soft S's (Style, Staff, Skills and Super-ordinate Goals). Clearly, all the S's have to complement each other and have to be aligned towards a single corporate vision for the organization to be effective. It has to be realized that most of the S's are determined directly or indirectly by the way Human Resources are managed, and therefore, *HRM must be a part of the total business strategy*.

1.7 HUMAN RESOURCE POLICIES

- Predetermined established guideline towards the attainment of accepted goals and objectives.
- Guidelines facilitate properly designed efforts to accomplish the strategic intent.

“A **policy** is a man-made rule of pre-determined course of action that is established to guide the performance of work toward the organisation objectives. It is a type of standing plan that serves to guide subordinates in the execution of their tasks”.

Objectives	Programmes	Procedure
------------	------------	-----------

Specific goals, aims , Quantitative terms which the Individual or group seeks to accomplish (Policy is the guide to accomplish)	It is developed on polices – simply the decisions – leads to specific action including practices and procedures.	Procedure defines the manner or way of accomplishing - It is process or method.
---	---	---

Policy Differentiated from Objectives , Programmes and Procedure

Flippo definition of policy

“is the man made rule of pre determined course of action that is established to guide the performance of work toward the organization objectives.”Yoder

“A policy is a pre determined, selected course established as a guide towards accepted goals and objectives. They establish the framework of guiding principles that facilitate delegation to lower levels and permit individual managers to select appropriate tactics or programmes.”

“Personnel Polices are those that individual have developed to keep them on track towards their personnel objectives. ”

Personnel Polices refer to principles and rules to conduct which *“Formulate, redefine, break into details and decide a number of actions ”* that govern the relationship with employees in the attainment of organizational objectives.

Personnel Polices are

- Key stone in the arch of the management
- Life blood for the successful functioning of the personnel management.
- Statement of intentions
- Positive declaration and command to an organization.

Need for a HR Policy

- Avoid unintended obligations
- Legal requirements

- Employment at will, contractual status
- Defense of claims
- Helps avoid union organizing
- Risk management
- Time saver

Features of a sound HR Policy

- Definite, positive, clear and easy to understand
- Written
- Reasonable stable
- Supplementary to all other policies of the orgn and the public policy.

Recognition and individual relationship between the mgmt and the employees

- Based on the facts
- Provide two way communication
- Supported by the mgmt, employees and the union
- Progressive
- Measurable
- Uniform for the entire organization
- Practically applicable

Aims and objective of Personnel polices

- Enable the orgn to carry out the main objectives
- Awareness of items in policies and to secure the co operation
- Sense of unity with the enterprise
- Provide competent , adequate and trained personnel for all levels and types of management
- To protect the common interest of all parties
- Recognize the role trade unions in the organization.
- Efficient consultative service.
- Management leadership
- Delegating the human relations
- Co operative understanding
- Security of employment

- Opportunity for growth
- Payment of fair and adequate wages
- To recognize the work and accomplishments
- To create the sense of responsibility.

Principles of HR policy

- Right man in the right place
- Train everyone for the job to be done
- Make the orgn a coordinated team

- SS the right tools and right conditions of work
- Give security with opportunity , incentive , recognition
- Look ahead, plan head for more and better things.

Types of HR Policies

- Functional vs centralized policy
 - Functional – Different categories of personnel
 - Centralized – Common throughout the orgn
- Minor vs Major
 - Minor – Relationship in a segment of an organization , with considerable emphasis on details and procedures.
 - Major – Overall objectives, procedures and control which affect an organization as whole.

Specific Policies

- Hiring – factors like reservation , martial status,
- Terms and conditions – compensation policy , hours of work, overtime , promotion , transfer, etc
- Medical assistance - sickness benefits
- Housing, transport, and other allowances.
- Training and development
- Industrial relations

Coverage of HR Policies

- Travel Pay
 - Work Records
 - Temporary & Casual
 - Appointments
 - Workweek & Pay Periods
 - Compensation
 - Employee Discipline
 - Pay bands
- Pay Advances
 - Sick Leave
 - Voting
 - Worker's Compensation
 - Labor Relations
 - Probation
 - Grievance Procedure
 - Ethical Conduct
 - Sick

- Salary Administration
- Relocation Pay
- Payroll Deductions
- Rates of Pay for New Employees
- Terminating Employees
- Layoff
- Performance
- Career Development
- Workshops and Seminars
- Family Health Leave
- Holidays
- Vacation
- Leaves of Absence Without Pay
- Personal Leave
- Orientation
- Vacancies
- Employment Offers
- References
- Interviewing
- Candidate Testing
- Transfers
- Consultants and Contractors
- Recruitment Advertising
- Continuous Service
- Retirement Plan
- Accidental Insurance

Why to adopt Policies

Following are the benefits of adopting the policies by the organization

- Complete thought of the basic needs of both organization and employees
- Established policies ensure consistent treatment of all personnel treatment throughout the organization
- Policy promotes stability – continuity of action
- It serve as a standard of performance
- Helps to build employee motivation and loyalty
- Helps to resolve interpersonal or intrapersonal and intergroup conflicts.

Formulating Policies

- Five principle source for determining the content and meaning of policies
 - Past practice
 - Prevailing practice in the rival companies
 - Attitudes and philosophies of the founders (Top level Management
 - Attitudes and philosophies of middle level management.
 - Knowledge and experience from handling personnel problems

Steps in design the Policy

1. Initiate a policy
2. Uncovering the facts by personnel department
3. Recommending a policy to top management
4. Put the policy in writing
5. Explaining and discussing the proposed policy with members
6. Adopting and launching it
7. Communicating it to employees to all levels
8. Administering it
9. Initiating a follow up
10. Evaluating it
11. Restating or Reformulating the policy

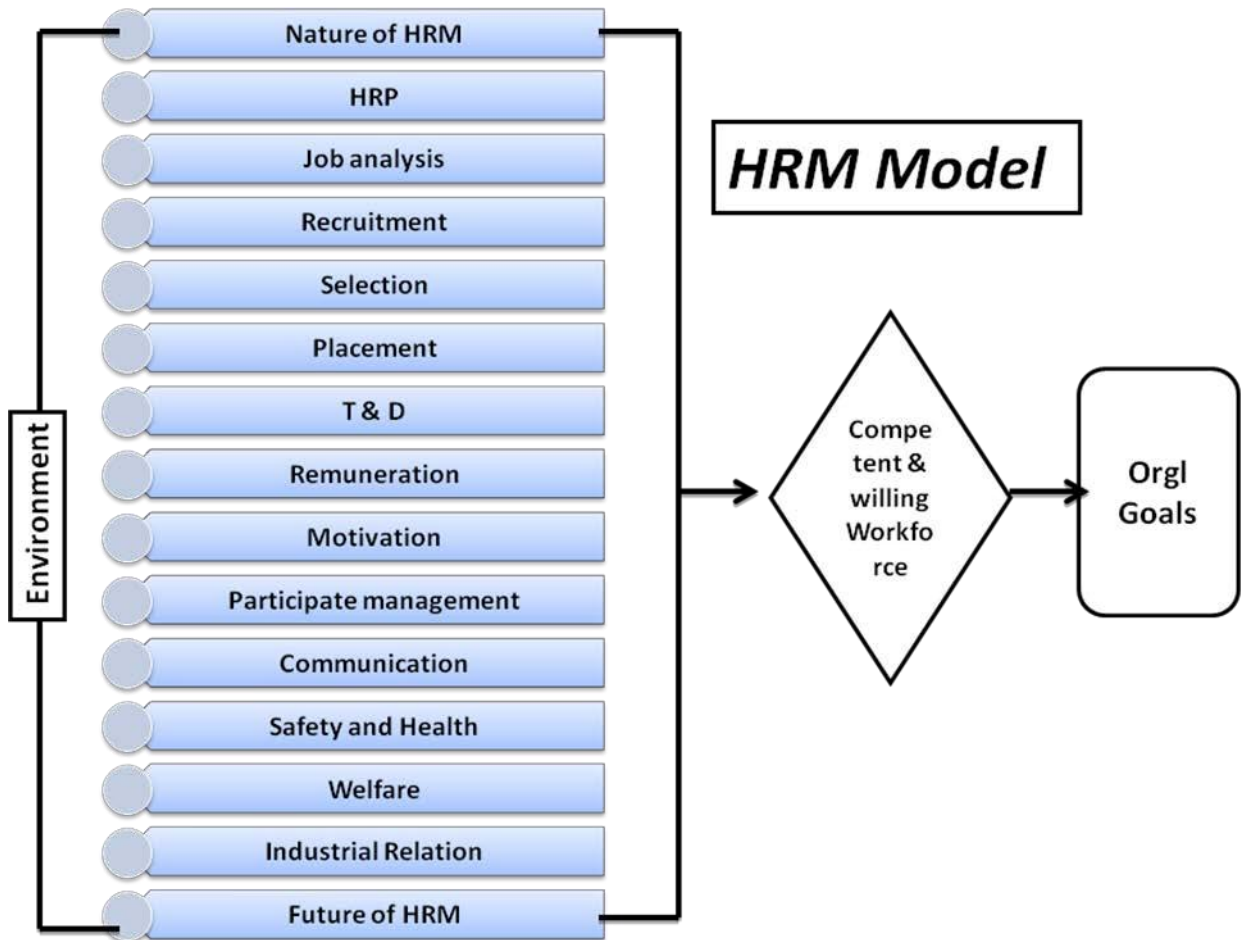

Elements of HR Policy

History of Company's Growth
Employment practice and condition of employment
Grievance of redressal procedure
Safety rules and regulation
Mutuality of interest and need for co operation
Employee financial aids
Educational Opportunities
Employees news sheet and house journal
Company policy

Collective bargaining
Procedures of disseminating information on company policies
Maintenance of discipline & Public Relations
Employees news sheet and house journal

1.8 Human source Information System (HRIS)

Acquisition , storage and retrieval of information is a significant challenge to the management

- **Human Resource Information System is a *systematic way of storing data and information for each individual employee to aid planning , decision making and submitting of returns and reports to the external agencies.***

1.8.1 Purpose of HRIS

- Storing information and data for each individual employee for future references
- Providing basis for planning, Organizing , Decision Making, Controlling and other Human resources function.
- Meeting daily transactional requirements- marking present / absent , and granting leave.
- Supply data and submitting returns to government and other statutory agencies

1.8.2 Applications of HRIS

- Personnel Administration
- Salary Administration
- Leave / absence recording
- Skill Inventory
- Medical History
- Accident Monitoring
- Performance Appraisal
- Training and Development
- HRP
- Recruitment
- Career Planning
- Collective Bargaining

1.8.3 Capabilities of HRIS

- **Input Function**

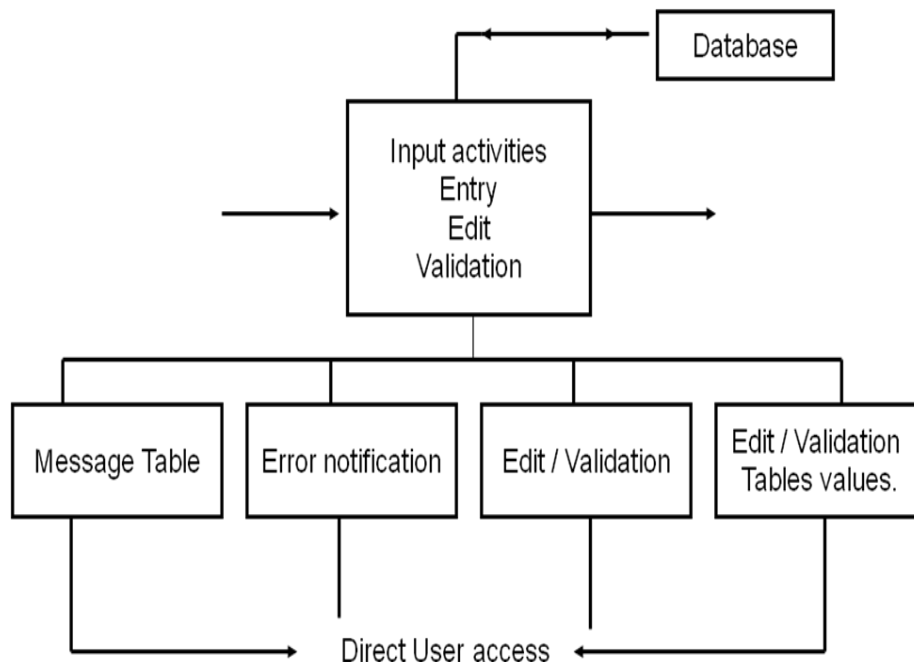

• **Data Maintenance Function**

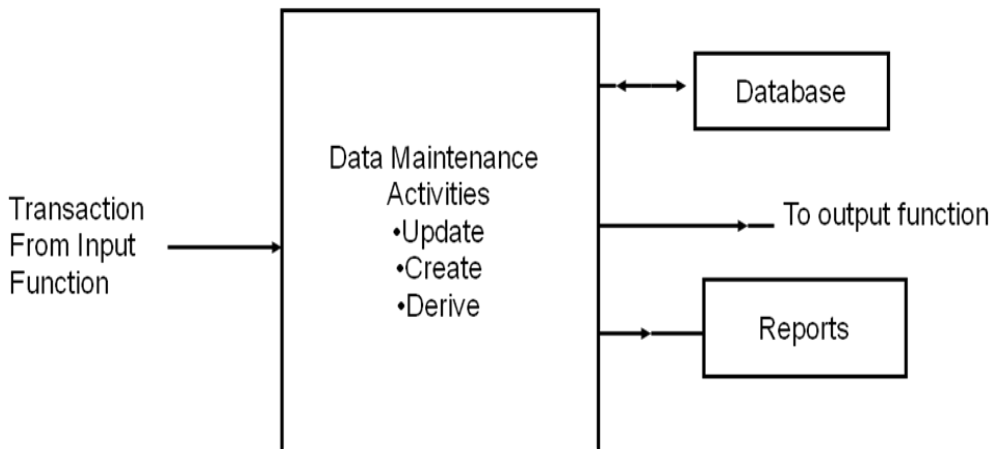

• **Output function**

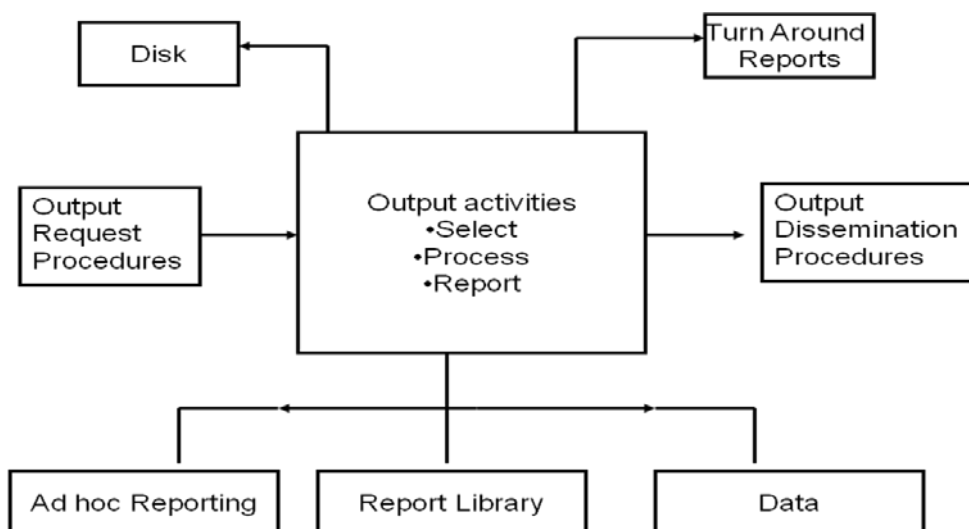

1.8.4 Steps in Implementing HRIS

- Inception of Data
 - Originator of the idea should prepare a report showing the need for an HRIS and benefits of this system towards the development of the organisation.

- Feasibility Study
 - It evaluates the Present system , details and benefits of HRIS .
 - It calculates the cost and benefits of HRIS

- Selecting a project team
 - Once the feasibility study has been accepted the resources are allocated
 - Project team is selected
 - HR representative, Representatives from both management , information systems & additional clerical people from HR department.

- Defining the requirements
 - Statement of requirements specifies in detail exactly what HRIS will do.
 - It is thw written descriptions of how users collect and prepare data,obtain approvals , complete forms, retrieve data and performa other non technical tasks associated with HRIS use.

- Vendor analysis
 - This step determines what software and hardware are available that will best meet the organisation needs for the lowest price.
 - The result of this analysis will determine whether to purchase an “off the shelf” package or develop the system internally

- Contract Negotiations
 - Vendor has to selected and the contract must be negotiated.The contract stipulates the vendor’s responsibilities with regard to software, installation, service, manintenance, training and Documentation.
 - Training

- Members of the project team are trained to use HRIS. HR representative will train managers from other department in how to submit information to HRIS and how to request information from it.
- Tailoring the system
 - This step involves making changes to the system to best fit the needs of organisation.
 - A general rule of thumb is to modify the vendor package , because of modifications frequently cause problems
- Collecting data
 - Data must be collected and stored in the system
- Testing system
 - Once the system is tailored to the organisationa needs and data is entered , a period of testing follows
 - The purpose of this testing is to verify the output
 - All reports are analysed for accuracy.
- Starting up
 - Start up begins when all current actions are put into the system and reports are produced
- Running in parallel
 - It is desirable to run the system in parallel with the old system for a period of time.
 - This allows for comparision of outputs both the system and examination for inaccuracies
- Maintenance
 - It normally takes several weeks and months for the employees to feel comfortable with the system. During the stabilisation period any remaining errors and adjustments should be handled.
- Evaluation
 - HRIS has been in plae for a reasonable length of time
 - The system has to be evaluted

- To check the efficiency whether the system is beneficial and properly used by the organisation

Benefits

- Higher speed of retrieval of information
- Reduction in duplication
- Ease in classifying and reclassifying
- Effective decision making
- Higher accuracy of information
- Fast response of queries
- Improve quality of people
- Better work culture
- Systematic procedures
- Transparency

Limitations

- Expensive – finance – manpower requirements
- Large scale computer literacy – inconvenient and threatening
- Personnel designing do not have the thorough information of the users- user do not get the exact reports.
- Quality of response depends on the accuracy of the input – human intervention .
- Multi user environment – system is operated in batch mode – records are updated once a week – online facility has to be developed – report generated should not be out of phase with the realities.

1.9 Human Resource Accounting & Audit – Definition

“Accounting for people as an organizational resource. It involves measuring the costs incurred by business firms and other organizations to recruit, select, hire, train and develop human assets. It involves measuring the economic value of people to the organization.”

Basic Information of HR

- Number of Employees
- Categories
- Grades
- Total Value of human resources
- Value per employee

HR Acquisition

- Number of employees acquired during the year
- Cost of Acquisition
- Levels for which they were acquired
- HR Development
- All information pertaining to HRD activities of the organization
- HR maintenance
- Cost related to HR maintenance.
- HR Separation
- Cost related to HR Separation, attribution rate.
- Details of benefits provided to the employees

Various Methods:

Non- Monetary Measurement
Monetary Measurement

on- Monetary Measurement

- Capitalization of Historical Cost
- Replacement Cost Method
- Opportunity Cost method
- Economic Value Method
- Present Value Method

HR Accounting

- Developing skill inventory
- Performance Appraisal
- Assessing the individual capacity for development
- Attitude survey
- Subjective Appraisal

CHAPTER II

THE CONCEPT OF BEST FIT EMPLOYEE

2.1 Concept of Human resource planning:

Human resource planning is important for helping both organizations and employees to prepare for the future. The basic goal of human resource planning is to predict the future and based on these predictions, implement programmes to avoid anticipated problems. Very briefly humans resource planning is the process of examining an organization's or individual's future human resource needs for instance, what types of skills will be needed for jobs of the future compared to future human resource capabilities (such as the types of skilled employees you already have) and developing human resource policies and practices to address potential problems for example, implementing training programmes to avoid skill deficiencies.

2.1.1 Definition of HRP:

According to Vetter, "HRP is the process by which management determines how the organization should move from its current man power position to desired manpower position. Through planning, management strives to have the right time, doing things which result in both the organization and individual receiving maximum long run benefits".

According to Gordon Mc Beath, "HRP is concerned with two things: Planning of manpower requirements and Planning of Manpower supplies".

According to Beach, "HRP is a process of determining and assuming that the organization will have an adequate number of qualified persons, available at proper times, performing jobs which meet the needs of the enterprise and which provides satisfaction for the individuals involved"

HRP is a Four-Phased Process.

- **The first phase** involves the gathering and analysis of data through manpower inventories and forecasts,
- **The second phase** consists of establishing manpower objectives and policies and gaining top management approval of these.
- **The third phase** involves designing and implementing plans and promotions to enable the organization to achieve its manpower objectives.
- **The fourth phase** is concerned with control and evaluation of manpower plans to facilitate progress in order to benefit both the organization and the individual. The long run view means that gains may be sacrificed in the short run for the future grounds. The planning process enables the organization to identify what its manpower needs is and what potential manpower problems required current action. This leads to more effective and efficient performance.

2.1.2 Nature of Human resource planning:

It is the process of analyzing and identifying the availability and the need for human resources so that the organization can meet its objectives. The focus of HR planning is to ensure that the organization has the right number of human resources, with the right capabilities, at the right times, and in the right places. In HR planning, an organization must consider the availability and allocation of people to jobs over long periods of time, not just for the next month or the next year¹.

HRP is a sub system in the total organizational planning. Actions may include shifting employees to other jobs in the organization, laying off employees or otherwise cutting back the number of employees, developing

present employees, and/or increasing the number of employees in certain areas. Factors to consider include the current employees' knowledge, skills, and abilities and the expected vacancies resulting from retirements, promotions, transfers, and discharges. To do this, HR planning requires efforts by HR professionals working with executives and managers.

2.1.3 Objectives of Human Resource Planning:

1. To ensure optimum utilization of human resources currently available in the organization.
2. To assess or forecast the future skill requirement of the Organization.
3. To provide control measures to ensure that necessary resources are available as and when required.
4. A series of specified reasons are there that attaches importance to manpower planning and forecasting exercises. They are elaborated below:
 - To link manpower planning with the organizational planning
 - To determine recruitment levels.
 - To anticipate redundancies.
 - To determine optimum training levels.
 - To provide a basis for management development programs.
 - To cost the manpower.
 - To assist productivity bargaining.
 - To assess future accommodation requirement.
 - To study the cost of overheads and value of service functions.
 - To decide whether certain activity needs to be subcontracted, etc.

HRP is the subsystem in the total organizational planning. Organizational planning includes managerial activities that set the company's objective for the future and determines the appropriate means for achieving those objectives. The **importance of HR** is elaborated on the basis of the key roles that it is playing in the organization.

1. **Future Personnel Needs:** Human resource planning is significant because it helps to determine the future personnel needs of the organization. If an organization is facing the problem of either surplus or deficiency in staff strength, then it is the result of the absence of effecting HR planning. All public sector enterprises find themselves overstaffed now as they never had any planning for personnel requirement and went of recruitment spree till late 1980's. The problem of excess staff has become such a prominent problem that many private sector units are resorting to VRS 'voluntary retirement scheme'. The excess of labor problem would have been there if the organization had good HRP system. Effective HRP system will also enable the organization to have good succession planning.
2. **Part of Strategic Planning:** HRP has become an integral part of strategic planning of strategic

planning. HRP provides inputs in strategy formulation process in terms of deciding whether the organization has got the right kind of human resources to carry out the given strategy. HRP is also necessary during the implementation stage in the form of deciding to make resource allocation decisions related to organization structure, process and human resources. In some organizations HRP play as significant role as strategic planning and HR issues are perceived as inherent in business management.

3. **Creating Highly Talented Personnel:** Even though India has a great pool of educated unemployed, it is the discretion of HR manager that will enable the company to recruit the right person with right skills to the organization. Even the existing staff hope the job so frequently that organization face frequent shortage of manpower. Manpower planning in the form of skill development is required to help the organization in dealing with this problem of skilled manpower shortage
4. **International Strategies:** An international expansion strategy of an organization is facilitated to a great extent by HR planning. The HR department's ability to fill key jobs with foreign nationals and reassignment of employees from within or across national borders is a major challenge that is being faced by international business. With the growing trend towards global operation, the need for HRP will as well will be the need to integrate HRP more closely with the organizations strategic plans. Without effective HRP and subsequent attention to employee recruitment, selection, placement, development, and career planning, the growing competition for foreign executives may lead to expensive and strategically descriptive turnover among key decision makers.
5. **Foundation for Personnel Functions:** HRP provides essential information for designing and implementing personnel functions, such as recruitment, selection, training and development, personnel movement like transfers, promotions and layoffs.
6. **Increasing Investments in Human Resources:** Organizations are making increasing investments in human resource development compelling the increased need for HRP. Organizations are realizing that human assets can increase in value more than the physical assets. An employee who gradually develops his/ her skills and abilities become a valuable asset for the organization. Organizations can make investments in its personnel either through direct training or job assignment and the rupee value of such a trained, flexible, motivated productive workforce is difficult to determine. Top officials have started acknowledging that quality of work force is responsible for both short term and long term performance of the organization.
7. **Resistance to Change:** Employees are always reluctant whenever they hear about change and even about job rotation. Organizations cannot shift one employee from one department to another without any specific planning. Even for carrying out job rotation (shifting one employee from one department to another) there is a need to plan well ahead and match the skills required and existing skills of the employees.
8. **Uniting the Viewpoint of Line and Staff Managers:** HRP helps to unite the viewpoints of line and staff managers. Though HRP is initiated and executed by the corporate staff, it requires the input and cooperation of all managers within an organization. Each department manager knows about the issues faced by his department more than anyone else. So communication between HR staff and line managers is essential for the success of HR Planning and development.
9. **Succession Planning:** Human Resource Planning prepares people for future challenges. The 'stars' are picked up, trained, assessed and assisted continuously so that when the time comes

such trained employees can quickly take the responsibilities and position of their boss or seniors as and when situation arrives.

10. Other Benefits: (a) HRP helps in judging the effectiveness of manpower policies and programmes of management. (b) It develops awareness on effective utilization of human resources for the overall development of organization. (c) It facilitates selection and training of employees with adequate knowledge, experience and aptitudes so as to carry on and achieve the organizational objectives (d) HRP encourages the company to review and modify its human resource policies and practices and to examine the way of utilizing the human resources for better utilization.

2.1.4 HRP Process:

HRP effectively involves forecasting personnel needs, assessing personnel supply and matching demand – supply factors through personnel related programmes. The HR planning process is influenced by overall organizational objectives and environment of business.

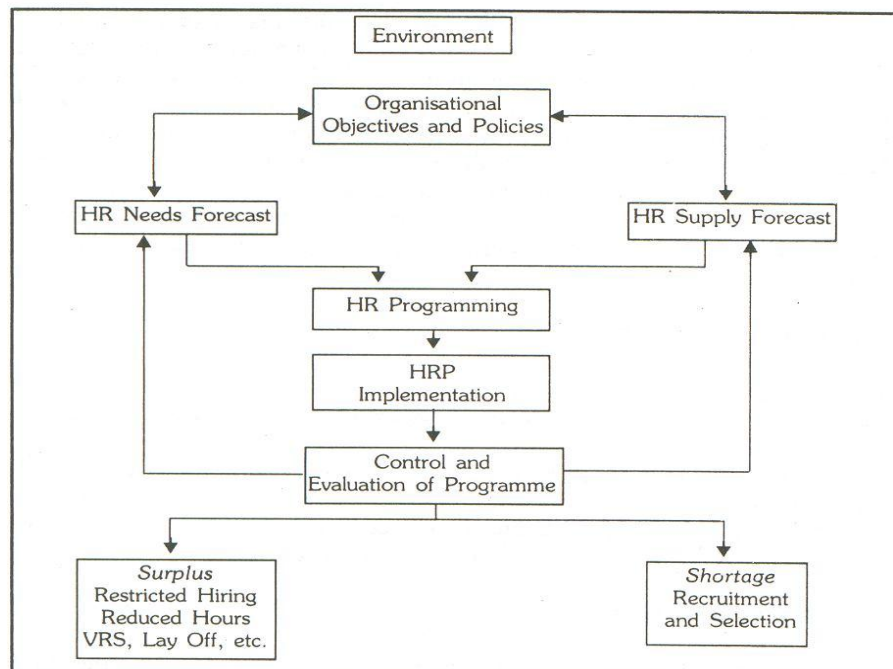

The HRP Process

Environmental Scanning:

It refers to the systematic monitoring of the external forces influencing the organization. The following forces are essential for pertinent HRP.

- Economic factors, including general and regional conditions.
- Technological changes
- Demographic changes including age, composition and literacy,
- Political and legislative issues, including laws and administrative rulings
- Social concerns, including child care, educational facilities and priorities.

By scanning the environment for changes that will affect an organization, managers can anticipate their impact and make adjustments early.

Organizational Objectives and Policies: HR plan is usually derived from the organizational objectives. Specific requirements in terms of number and characteristics of employees should be derived from

organizational objectives

Once the organizational objectives are specified, communicated and understood by all concerned, the HR department must specify its objective with regard to HR utilization in the organization.

HR Demand Forecast:

Demand forecasting is the process of estimating the future quantity and quality of people required to meet the future needs of the organization. Annual budget and long-term corporate plan when translated into activity into activity form the basis for HR forecast.

For eg: in the case of a manufacturing company, the sales budget will form the basis for production plan giving the number and type of products to be produced in each period. This will form the basis upon which the organization will decide the number of hours to be worked by each skilled category of workers. Once the number hours required is available organization can determine the quality and quantity of personnel required for the task.

Demand forecasting is influenced by both internal factors and external factors: external factors include-competition, economic climate, laws and regulatory bodies, changes in technology and social factors whereas internal factors are budget constraints, production level, new products and services, organizational structure and employee separations.

Demand forecasting is essential because it helps the organization to 1. Quantify the jobs, necessary for producing a given number of goods, 2. To determine the nature of staff mix required in the future, 3. To assess appropriate levels in different parts of organization so as to avoid unnecessary costs to the organization, 4. To prevent shortages of personnel where and when, they are needed by the organization. 5. To monitor compliances with legal requirements with regard to reservation of jobs.

Techniques like managerial judgment, ratio- trend analysis, regression analysis, work study techniques, Delphi techniques are some of the major methods used by the organization for demand forecasting.

HR Supply Forecast:

Supply forecast determines whether the HR department will be able to procure the required number of workers. Supply forecast measures the number of people likely to be available from within and outside an organization, after making allowance for absenteeism, internal movements and promotions, wastage and changes in hours, and other conditions of work.

Supply forecast is required because it is needed as it 1. Helps to quantify the number of people and positions expected to be available in future to help the organization realize its plans and meet its objectives 2. Helps to clarify the staff mixes that will arise in future 3. It assesses existing staffing in different parts of the organization. 4. It will enable the organization to prevent shortage of people where and when they are most needed. 5. It also helps to monitor future compliance with legal requirements of job reservations.

Supply analysis covers the existing human resources, internal sources of supply and external sources of supply.

HR Programming:

Once an organization's personnel demand and supply are forecasted the demand and supply need to be balanced in order that the vacancies can be filled by the right employees at the right time.

HR Plan Implementation:

HR implementation requires converting an HR plan into action. A series of action are initiated as a part of HR plan implementation. Programmes such as recruitment, selection and placement, training and development, retraining and redeployment, retention plan, succession plan etc when clubbed together form the implementation part of the HR plan.

Control and Evaluation:

Control and evaluation represent the final phase of the HRP process. All HR plan include budgets, targets and standards. The achievement of the organization will be evaluated and monitored against the plan. During this final phase organization will be evaluating on the number of people employed against the established (both those who are in the post and those who are in pipe line) and on the number recruited against the recruitment targets. Evaluation is also done with respect to employment cost against the budget and wastage accrued so that corrective action can be taken in future.

2.1.5 Requisites for Successful HRP

1. HRP must be recognized as an integral part of corporate planning
2. Support of top management is essential
3. There should be some centralization with respect to HRP responsibilities in order to have co-ordination between different levels of management.
4. Organization records must be complete, up to date and readily available.
5. Techniques used for HR planning should be those best suited to the data available and degree of accuracy required.
6. Data collection, analysis, techniques of planning and the plan themselves need to be constantly revised and improved in the light of experience.

2.1.6 Barriers to HRP

Human Resource Planners face significant barriers while formulating an HRP. The major barriers are elaborated below:

- 1) HR practitioners are perceived as experts in handling personnel matters, but are not experts in managing business. The personnel plan conceived and formulated by the HR practitioners when enmeshed with organizational plan, might make the overall strategic plan of the organization ineffective.
- 2) HR information often is incompatible with other information used in strategy formulation. Strategic planning efforts have long been oriented towards financial forecasting, often to the exclusion of other types of information. Financial forecasting takes precedence over HRP.
- 4) Conflict may exist between short term and long term HR needs. For example, there can be a conflict between the pressure to get the work done on time and long term needs, such as preparing people for assuming greater responsibilities. Many managers are of the belief that HR needs can be met immediately because skills are available on the market as long as wages and salaries are competitive. Therefore, long times plans are not required, short planning are only needed.
- 5) There is conflict between quantitative and qualitative approaches to HRP. Some people view HRP as a number game designed to track the flow of people across the department. Others take a qualitative approach and focus on individual employee concerns such as promotion and career development. Best result can be achieved if there is a balance between the quantitative and qualitative approaches.
- 6) Non-involvement of operating managers renders HRP ineffective. HRP is not strictly an HR department function. Successful planning needs a co-ordinated effort on the part of operating managers and HR personnel.

2.2 Sources of Recruitment

After the finalisation of recruitment plan indicating the number and type of prospective candidates, they must be attracted to offer themselves for consideration to their employment. This necessitates the identification of sources from which these candidates can be attracted. Some companies try to develop new sources, while most only try to tackle the existing sources they have. These sources, accordingly, may be termed as internal and external.

Internal Sources

It would be desirable to utilise the internal sources before going outside to attract the candidates. Yoder and others suggest two categories of internal sources including a review of the present employees and nomination of candidates by employees. Effective utilisation of internal sources necessitates an understanding of their skills and information regarding relationships of jobs. This will provide possibilities for horizontal and vertical transfers within the enterprise eliminating simultaneous attempts to lay off employees in one department and recruitment of employees with similar qualification for another department in the company. Promotion and transfers within the plant where an employee is best suitable improves the morale along with solving recruitment problems. These measures can be taken effectively if the company has established job families through job analysis programmes combining together similar jobs demanding similar employee characteristics. Again, employees can be requested to suggest promising candidates. Sometimes, employees are given prizes for recommending a candidate who has been recruited. Despite the usefulness of this system in the form of loyalty and its wide practice, it has been pointed out that it gives rise to cliques posing difficulty to management. Therefore, before utilising this system attempts should be made to determine through research whether or not employees thus recruited are effective on particular jobs. Usually, internal sources can be used effectively if the numbers of vacancies are not very large, adequate, employee records are maintained, jobs do not demand originality lacking in the internal sources, and employees have prepared themselves for promotions.

Merits of Internal Sources: The following are the merits of internal sources of recruitment:

- It creates a sense of security among employees when they are assured that they would be preferred in filling up vacancies.
It improves the morale of employees, for they are assured of the fact that they would be preferred over outsiders when vacancies occur.
- It promotes loyalty and commitment among employees due to sense of job security and opportunities for advancement.
- The employer is in a better position to evaluate those presently employed than outside candidates. This is because the company maintains a record of the progress, experience and service of its employees.
- Time and costs of training will be low because employees remain familiar with the organisation and its policies.
- Relations with trade unions remain good. Labour turnover is reduced.
- As the persons in the employment of the company are fully aware of, and well acquainted with, its policies and know its operating procedures, they require little training, and the chances are that they would stay longer in the employment of the organisation than a new outsider would.
- It encourages self-development among the employees. It encourages good individuals who are ambitious.
- It encourages stability from continuity of employment.
- It can also act as a training device for developing middle and top-level managers.

Demerits of Internal Sources: However, this system suffers from certain defects as:

- There are possibilities that internal sources may “dry up”, and it may be difficult to find the requisite personnel from within an organisation.
- It often leads to inbreeding, and discourages new blood from entering and organisation.
- As promotion is based on seniority, the danger is that really capable hands may not be chosen. The likes and dislikes of the management may also play an important role in the selection of personnel.
- Since the learner does not know more than the lecturer, no innovations worth the name can be made. Therefore, on jobs which require original thinking (such as advertising, style, designing and basic research), this practice is not followed.

This source is used by many organisations; but a surprisingly large number ignore this source, especially for middle management jobs.

External Sources

DeCenzo and Robbins remark, “Occasionally, it may be necessary to bring in some ‘new blood’ to broaden the present ideas, knowledge, and enthusiasm.” Thus, all organisations have to depend on external sources of recruitment. Among these sources are included:

- Employment agencies.
- Educational and technical institutes. and
- Casual labour or “applicants at the gate” and nail applicants.

Public and private employment agencies play a vital role in making available suitable employees for different positions in the organisations. Besides public agencies, private agencies have developed markedly in large cities in the form of consultancy services. Usually, these agencies facilitate recruitment of technical and professional personnel. Because of their specialisation, they effectively assess the needs of their clients and aptitudes and skills of the specialised personnel. They do not merely bring an employer and an employee together but computerise lists of available talents, utilising testing to classify and assess applicants and use advanced techniques of vocational guidance for effective placement purposes.

Educational and technical institutes also form an effective source of manpower supply. There is an increasing emphasis on recruiting student from different management institutes and universities commerce and management departments by recruiters for positions in sales, accounting, finance, personnel and production. These students are recruited as management trainees and then placed in special company training programmes. They are not recruited for particular positions but for development as future supervisors and executives. Indeed, this source provides a constant flow of new personnel with leadership potentialities. Frequently, this source is tapped through on-campus interview with promising students. In addition, vocational schools and industrial training institutes provide specialised employees, apprentices, and trainees for semiskilled and skilled jobs. Persons trained in these schools and institutes can be placed on operative and similar jobs with a minimum of in-plant training. However, recruitment of these candidates must be based on realistic and differential standards established through research reducing turnover and enhancing productivity.

Frequently, numerous enterprises depend to some extent upon casual labour or “applicants at the gate” and nail applicants. The candidates may appear personally at the company’s employment office or send their applications for possible vacancies. Explicitly, as Yoder and others observe, the quality and quantity of such candidates depend on the image of the company in community. Prompt response to these applicants proves very useful for the company. However, it may be noted that this source is uncertain, and the applicants reveal a wide range of abilities necessitating a careful screening. Despite these limitations, it forms a highly inexpensive source as the candidates themselves come to the gate of the company. Again, it provides measures for good public relations and accordingly, all the candidates visiting the company must be received cordially.

Table : Recruiting Sources Used by Skill and Level

Skill/Level	Recruiting Source	Percentage of Use
Unskilled and Semiskilled	Informal contacts	85
	Walk-ins	74
	Public Employment Agencies	66
	Want Ads	52
Skilled	Informal Contacts	88
	Walk-ins	66
	Public Employment Agencies	55
	Want Ads	55
Professional Employees	Internal Search	94
	Informal Contacts	92
	Walk-ins	71
	Public Employment Agencies	52
	Want Ads	48
	Private Employment Agencies	22
Managerial Level	Internal Search	100
	Informal Contacts	71
	Walk-ins	31
	Private Employment Agencies	20
	Want Ads	17
	Public Employment Agencies	12

As Jucius observes, trade unions are playing an increasingly important role in labour supply. In several trades, they supply skilled labour in sufficient numbers. They also determine the order in which employees are to be recruited in the organisation. In industries where they do not take active part in recruitment, they make it a point that employees laid off are given preference in recruitment.

Application files also forms a useful source of supply of work force. Attempts may be made to review the application to determine jobs for which the candidates filed for future use when there are openings in these jobs. The candidates may be requested to renew their cards as many times as they desire. All the renewed cards may be placed in “active” files and those not renewed for considerable time may be placed in “inactive” file or destroyed. Indeed, a well-indexed application file provides utmost economy from the standpoint of a recruiting budget.

Efficacy of alternative sources of supply of human resources should be determined through research. Attempts may be made to relate the factor of success on the job with a specific source of supply. Alternative sources can also be evaluated in terms of turnover, grievances and disciplinary action. Those sources which are significantly positively related with job performance and significantly negatively related with turnover, grievances and disciplinary action, can be effectively used in recruitment programmes. The assessment should be periodically performed in terms of occupations. It may be that source “A” is most effective for technical workers, while source “B” for semiskilled workers.

Advantages of External Recruitment: External sources of recruitment are suitable for the following reasons:

- It will help in bringing new ideas, better techniques and improved methods to the organisation.
- The cost of employees will be minimised because candidates selected in this method will be placed in the minimum pay scale.
- The existing employees will also broaden their personality.
- The entry of qualitative persons from outside will be in the interest of the organisation in the long run.
- The suitable candidates with skill, talent, knowledge are available from external sources.
- The entry of new persons with varied expansion and talent will help in human resource mix.

Disadvantages of External Sources:

- Orientation and training are required as the employees remain unfamiliar with the organisation.
- It is more expensive and time-consuming. Detailed screening is necessary as very little is known about the candidate.
- If new entrant fails to adjust himself to the working in the enterprise, it means yet more expenditure on looking for his replacement.
- Motivation, morale and loyalty of existing staff are affected, if higher level jobs are filled from external sources. It becomes a source of heart-burning and demoralisation among existing employees.

2.3 RECRUITMENT: Recruitment forms a step in the process which continues with selection and ceases with the placement of the candidate. It is the next step in the procurement function, the first being the manpower planning. Recruiting makes it possible to acquire the number and types of people necessary to ensure the continued operation of the organisation. Recruiting is the discovering of potential applicants for actual or anticipated organisational vacancies.

According to Edwin B. Flippo, “Recruitment is the process of searching for prospective employees and

stimulating them to apply for jobs in the organisation.”

According to Lord, “Recruitment is a form of competition. Just as corporations compete to develop, manufacture, and market the best product or service, so they must also compete to identify, attract and hire the most qualified people. Recruitment is a business, and it is a big business.”

In the words of Dale Yoder, “ Recruiting is a process to discover the sources of manpower to meet the requirements of the staffing schedule and to employ effective measures for attracting that manpower in adequate numbers to facilitate effective selection of an efficient working force.”

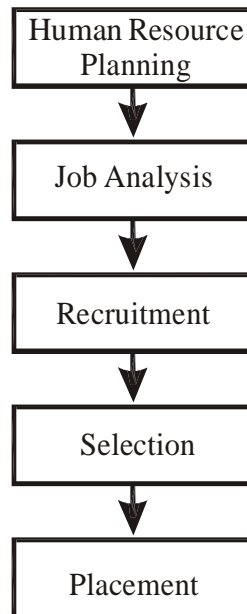

Recruitment to Human Resource Acquisition Process

According to Werther and Davis, “Recruitment is the process of finding and attracting capable applicants for employment. The process begins when new recruits are sought and ends when their applications are submitted. The result is a pool of applicants from which new employees are selected.”

Dales S. Beach writes, “Recruitment is the development and maintenance of adequate manpower resources. It involves the creation of a pool of available labour upon whom the organisation can depend when it needs additional employees.”

Thus, recruitment process is concerned with the identification of possible sources of human resource supply and tapping those sources. In the total process of acquiring and placing human resources in the organisation, recruitment falls in between different sub-processes as shown in Figure 4.2.

According to Scott, Clothier and Spriegel the need for recruitment arises out of the following situations:

- Vacancies created due to expansion, diversification, and growth of business.
- An increase in the competitive advantage of certain concerns, enabling them to get more of the available business than formerly.
- An increase in business arising from an upswing during the recovery period of a business cycle.
- Vacancies created due to transfer, promotion, retirement, termination, permanent disability or death.
- The normal population growth, which requires increased goods and services to meet the needs of the people.
- A rising standard of living, which requires more of the same goods and services as well as the creation of new wants to be satisfied.

2.3.1 Process of Recruitment

Recruitment process passes through the following stages:

- Recruitment process begins when the personnel department receives requisitions for recruitment from any department of the company, The personnel requisitions contain details about the position to be filled, number of persons to be recruited, the duties to be performed, qualifications expected from the candidates, terms and conditions of employment and the time by which the persons should be available for appointment etc.
- Locating and developing the sources of required number and type of employees.
- Identifying the prospective employees with required characteristics.
- Developing the techniques to attract the desired candidates. The goodwill of an organisation in the market may be one technique. The publicity about the company being a good employer may also help in stimulating candidates to apply. There may be others of attractive salaries, proper facilities for development etc.
- Evaluating the effectiveness of recruitment process.

According to Famularo, personnel recruitment process involves five elements, viz., a recruitment policy, a recruitment organisation, a forecast of manpower, the development of sources of recruitment, and different techniques used for utilising these sources, and a method of assessing the recruitment programme. The explanation of these is described below:

1. Recruitment Policy: It specifies the objectives of recruitment and provides a framework for the implementation of the recruitment programme. It also involves the employer's commitment to some principles as to find and employ the best qualified persons for each job, to retain the most promising of those hired, etc. It should be based on the goals, needs and environment of the organisation.

2. Recruitment Organisation: The recruitment may be centralised like public sector banks or decentralised. Both practices have their own merits. The choice between the two will depend on the managerial philosophy and the particular needs of the organisation.

3. Sources of Recruitment: Various sources of recruitment may be classified as internal and external. These have their own merits and demerits.

4. Methods of Recruitment: Recruitment techniques are the means to make contact with potential candidates, to provide them necessary information and to encourage them to apply for jobs.

5. Evaluation of Recruitment Programme: The recruitment process must be evaluated periodically. The criteria for evaluation may consist of cost per applicant, the hiring ratio, performance appraisal, tenure of stay, etc. After evaluation, necessary improvements should be made in the recruitment programme.

2.3.2 Recruitment Policy

As Yoder et al observe recruitment policy spells out the objectives of the recruitment and provides a framework for implementations of the recruitment programme in the form of procedures. It may involve a commitment to broad principles such as filling vacancies with the best qualified individuals. The recruitment policy may embrace several issues such as the extent of promotion from within, attitudes of enterprise in recruiting old, handicapped, and minor individuals, minority group members, part-time employees and relatives of present employees. In addition, the recruitment policy may also involve the organisation system to be developed for implementing the recruitment programme and procedures to be employed. Explicitly, an organisational system is a function of the size of an enterprise. In smaller enterprises, there may be merely informal recruiting procedures and the line official may be responsible to handle this function along with their usual responsibilities. On the other hand, in larger organisations, there is usually a staff unit

attached with personnel or an industrial relations department designated as employment or recruitment office. This specialisation of recruitment enables staff personnel to become highly skilled in recruitment techniques and their evaluation. However, recruitment remains the line responsibility as far as the personnel requisition forms are originated by the line personnel, who have also the final word in the acceptance or rejection of a particular applicant. Despite this, the staff personnel have adequate freedom in respect of sources of manpower to be tapped and the procedure to be followed for this purpose.

Recruitment policy covers the following areas:

- To prescribe the degree of emphasis. Inside the organisation or outside the organisation.
- To provide the weightage that would be given to certain categories of people such as local population, physically-handicapped personnel, personnel from scheduled castes/tribes and other backward classes.
- To prescribe whether the recruitment would be centralised or decentralised at unit levels.
- To specify the degree of flexibility with regard to age, qualifications, compensation structure and other service conditions.
- To prescribe the personnel who would be involved in recruitment process and the role of human resource department in this regard.
- To specify the budget for meeting the expenditures incurred in completing the recruitment process.

According to Yoder, “the recruitment policy is concerned with quantity and qualifications of manpower.” It establishes broad guidelines for the staffing process. Generally, the following factors are involved in a recruitment policy:

- To provide each employee with an open road and encouragement in the continuing development of his talents and skills;
- To provide individual employees with the maximum of employment security, avoiding, frequent lay-off or lost time;
- To avoid cliques which may develop when several members of the same household or community are employed in the organisation;
- To carefully observe the letter and spirit of the relevant public policy on hiring and, on the whole, employment relationship;
- To assure each employee of the organisation interest in his personal goals and employment objective;
- To assure employees of fairness in all employment relationships, including promotions and transfers;
- To provide employment in jobs which are engineered to meet the qualifications of handicapped workers and minority sections; and
- To encourage one or more strong, effective, responsible trade unions among the employees.

Prerequisites of a Good Recruitment Policy: The recruitment policy of an organisation must satisfy the following conditions:

- It should be in conformity with its general personnel policies;
- It should be flexible enough to meet the changing needs of an organisation;
- It should be so designed as to ensure employment opportunities for its employees on a long-term basis so that the goals of the organisation should be achievable; and it should develop the potentialities of employees;
- It should match the qualities of employees with the requirements of the work for which they are employed; and
- It should highlight the necessity of establishing job analysis.

2.3.3 Factor Affecting Recruitment

The factors affecting recruitment can be classified as internal and external factors.

The internal factors are:

- Wage and salary policies;
- The age composition of existing working force;
- Promotion and retirement policies;
- Turnover rates;
- The nature of operations involved the kind of personnel required;
- The level and seasonality of operations in question;
- Future expansion and reduction programmes;
- Recruiting policy of the organisation;
- Human resource planning strategy of the company;
- Size of the organisation and the number of employees employed;

- Cost involved in recruiting employees, and finally;
- Growth and expansion plans of the organisation.

The external factors are:

- Supply and demand of specific skills in the labour market;
- Company's image perception of the job seekers about the company.
- External cultural factors: Obviously, the culture may exert considerable check on recruitment. For example, women may not be recruited in certain jobs in industry.
- Economic factors: such as a tight or loose labour market, the reputation of the enterprise in the community as a good pay master or otherwise and such allied issues which determine the quality and quantity of manpower submitting itself for recruitment.
- Political and legal factors also exert restraints in respect of nature and hours of work for women and children, and allied employment practices in the enterprise, reservation of Job for SC, ST and so on.

2.3.4 Methods of Recruitment

Methods of recruitment are different from the sources of recruitment. Sources are the locations where prospective employees are available. On the other hand, methods are way of establishing links with the prospective employees. Various methods employed for recruiting employees may be classified into the following categories:

1. Direct Methods:

These include sending recruiters to educational and professional institutions, employees, contacts with public, and manned exhibits. One of the widely used direct methods is that of sending of recruiters to colleges and technical schools. Most college recruiting is done in co-operation with the placement office of a college. The placement office usually provides help in attracting students, arranging interviews, furnishing space, and providing student resumes.

For managerial, professional and sales personnel campus recruiting is an extensive operation. Persons reading for MBA or other technical diplomas are picked up in this manner. For this purpose, carefully prepared brochures, describing the organisation and the jobs it offers, are distributed among students, before the interviewer arrives. Sometimes, firms directly solicit information from the concerned professors about students with an outstanding record. Many companies have found employees contact with the public a very effective method. Other direct methods include sending recruiters to conventions and seminars, setting up exhibits at fairs, and using mobile offices to go to the desired centre

Based on personnel to be recruited	
Managerial/technical personnel	Operative personnel
Advertisement Internet Walk-ins Campus recruitments Job fairs Consultancy firms Personnel contacts Poaching and raiding	Public employment exchanges Labour unions Employee referrals Gate hiring Labour contractors
Based on the movement of the organisation	
Direct methods	Third party method
Advertisement Internet recruiting Campus recruitment Job fairs Personnel contacts Gate hiring	Consultancy firms Public employment exchanges Labour unions Employee referrals Labour contractors

2. Indirect Methods:

The most frequently used indirect method of recruitment is advertisement in newspapers, journals, and on the radio and television. Advertisement enables candidates to assess their suitability. It is appropriate when the organisation wants to reach out to a large target group scattered nationwide. When a firm wants to conceal its identity, it can give blind advertisement in which only box number is given. Considerable details about jobs and qualifications can be given in the advertisements. Another method of advertising is a notice-board placed at the gate of the company.

3. Third-Party Methods:

The most frequently used third-party methods are public and private employment agencies. Public employment exchanges have been largely concerned with factory workers and clerical jobs. They also provide help in recruiting professional employees. Private agencies provide consultancy services and charge a fee. They are usually specialised for different categories of operatives, office workers, salesmen, supervisory and management personnel. Other third-party methods include the use of trade unions. Labour-management committees have usually demonstrated the effectiveness of trade unions as methods of recruitment.

2.5 Selection

Human resource selection is the process of choosing qualified individuals who are available to fill positions in an organization. In the ideal personnel situation, selection involves choosing the best applicant to fill a position. Selection is the process of choosing people by obtaining and assessing information about the applicants with a view to matching these with the job requirements. It involves a careful screening and testing of candidates who have put in their applications for any job in the enterprise. It is the process of choosing the most suitable persons out of all the applicants. The purpose of selection is to pick up the right person for every job.

It can be conceptualised in terms of either choosing the fit candidates, or rejecting the unfit candidates, or a combination of both. Selection involves both because it picks up the fits and rejects the unfits. In fact, in Indian context, there are more candidates who are rejected than those who are selected in most of the

selection processes. Therefore, sometimes, it is called a negative process in contrast to positive programme of recruitment.

According to Dale Yoder, “Selection is the process in which candidates for employment are divided into two classes-those who are to be offered employment and those who are not”.

According to Thomas Stone, “Selection is the process of differentiating between applicants in order to identify (and hire) those with a greater likelihood of success in a job”.

In the words of Michael Jucius, “The selection procedure is the system of functions and devices adopted in a given company for the purpose of ascertaining whether or not candidates possess the qualifications called for by a specific job or for progression through a series of jobs.”

According to Keith Davis, “Selection is the process by which an organisation chooses from a list of screened applicants, the person or persons who best meet the selection criteria for the position available.”

Thus, the selection process is a tool in the hands of management to differentiate between the qualified and unqualified applicants by applying various techniques such as interviews, tests etc. The cost incurred in recruiting and selecting any new employee is expensive. The cost of selecting people who are inadequate performers or who leave the organisation before contributing to profits proves a major cost of doing business. Decenzo and Robbins write, “Proper selection of personnel is obviously an area where effectiveness - choosing competent workers who perform well in their position-can result in large saving.” According to them, selection has two objectives: (1) to predict which job applicants would be successful if hired and (2) to inform and sell the candidate on the job and the organization. Satisfaction of employee needs and wants as well as the fullest development of his potential are important objectives of selection.

Dale Yoder says, “Selection has long held a high rank in the priority of problem areas in management. Investments in good people produce a very high rate of return. A good choice of people can provide a basis for long, sustained contributions.”

Difference between Recruitment and Selection: Difference between recruitment and selection has been described by Flippo as, “Recruitment is a process of searching for prospective employees and stimulating and encouraging them to apply for jobs in an organisation. It is often termed positive as it stimulates people to apply for jobs, selection on the other hand tends to be negative because it rejects a good number of those who apply, leaving only the best to be hired.” Recruitment and selection differs in following manner:

1. Difference in Objective: The basic objective of recruitment is to attract maximum number of candidates so that more options are available. The basic objective of selection is to choose best out of the available candidates.

2. Difference in Process: Recruitment adopts the process of creating application pool as large as possible and therefore. It is known as positive process. Selection adopts the process through which more and more candidates are rejected and fewer candidates are selected or sometimes even not a single candidate is selected. Therefore, it is known as negative process or rejection process.

3. Technical Differences: Recruitment techniques are not very intensive, and not require high skills. As against this, in selection process, highly specialised techniques are required. Therefore, in the selection

process, only personnel with specific skills like expertise in using selection tests, conducting interviews, etc., are involved.

4. Difference in Outcomes: The outcome of recruitment is application pool which becomes input for selection process. The outcome of selection process is in the form of finalising candidates who will be offered jobs.

2.5.1 Selection Procedure

The selection procedure is concerned with securing relevant information about an applicant. This information is secured in a number of steps or stages. The objective of selection process is to determine whether an applicant meets the qualification for a specific job and to choose the applicant who is most likely to perform well in that job. Selection is a long process, commencing from the preliminary interview of the applicants and ending with the contract of employment (sometimes).

The selection procedure consists of a series of steps. Each step must be successfully cleared before the applicant proceeds to the next. The selection process is a series of successive hurdles or barriers which an applicant must cross. These hurdles are designed to eliminate an unqualified candidate at any point in the selection process. Thus, this technique is called “Successive Hurdles Technique”. In practice, the process differs among organisations and between two different jobs within the same organisation. Selection procedure

for the senior managers will be long drawn and rigorous, but it is simple and short while hiring lower level employees.

The major factors which determine the steps involved in a selection process are as follows:

- Selection process depends on the number of candidates that are available for selection.
- Selection process depends on the sources of recruitment and the method that is adopted for making contact with the prospective candidates.
- Various steps involved in as selection process depend on the type of personnel to be selected. All the above factors are not mutually exclusive, rather these operate simultaneously. In any case, the basic objective of a selection process is to collect as much relevant information about the candidates as is possible so that the most suitable candidates are selected. A comprehensive selection process involves the various steps:

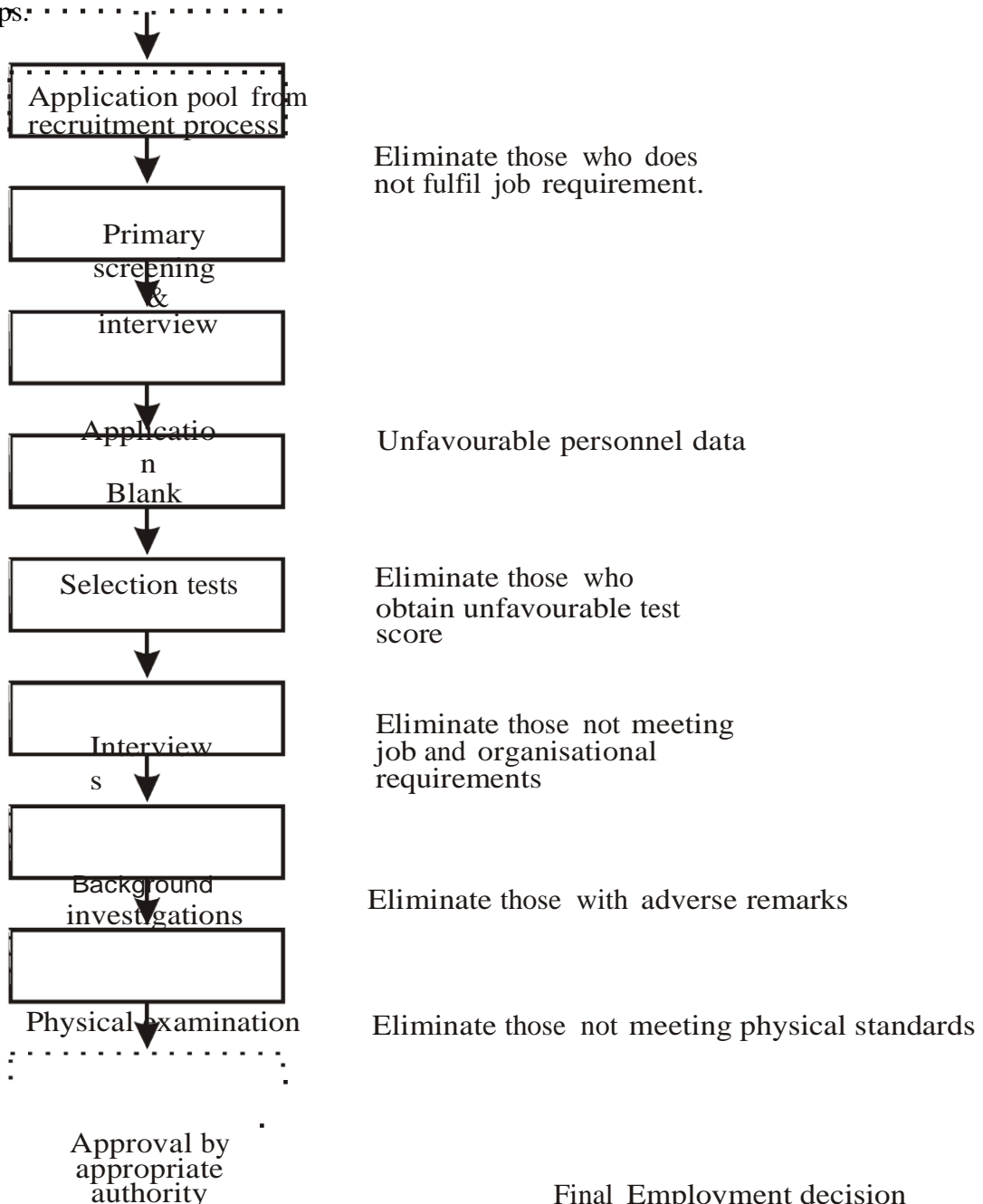

Evaluation	:	congratulate
Adopt objectivity	:	Check the reliability and validity

Steps in Selection Process

1. Application Pool: Application pool built-up through recruitment process is the base for selection process. The basic objective at the recruitment level is to attract as much worthwhile applications as possible so that there are more options available at the selection stage.

2. Preliminary Screening and Interview: It is highly noneconomic to administer and handle all the applicants. It is advantageous to sort out unsuitable applicants before using the further selection steps. For this purpose, usually, preliminary interviews, application blank lists and short test can be used. All applications received are scrutinised by the personnel department in order to eliminate those applicants who do not fulfil required qualifications or work experience or technical skill, his application will not be entertained. Such candidate will be informed of his rejection.

Preliminary interview is a sorting process in which the prospective candidates are given the necessary information about the nature of the job and the organisation. Necessary information is obtained from the candidates about their education, skills, experience, expected salary etc. If the candidate is found suitable, he is elected for further screening. This courtesy interview; as it is often called helps the department screen out obvious misfits. Preliminary interview saves time and efforts of both the company and the candidate. It avoids unnecessary waiting for the rejected candidates and waste of money on further processing of an unsuitable candidate. Since rejection rate is high at preliminary interview, the interviewer should be kind, courteous, receptive and informal.

3. Application Blank or Application Form: An application blank is a traditional widely accepted device for getting information from a prospective applicant which will enable the management to make a proper selection. The blank provides preliminary information as well as aid in the interview by indicating areas of interest and discussion. It is a good means of quickly collecting verifiable (and therefore fairly accurate) basic historical data from the candidate. It also serves as a convenient device for circulating information about the applicant to appropriate members of management and as a useful device for storing information for, later reference. Many types of application forms, sometimes very long and comprehensive and sometimes brief, are used. Information is generally taken on the following items:

(a) Biographical Data: Name, father's name, date and place of birth, age, sex, nationality, height, weight, identification marks, physical disability, if any, marital status, and number of dependants.

(b) Educational Attainment: Education (subjects offered and grades secured), training acquired in special fields and knowledge gained from professional/technical institutes or through correspondence courses.

(c) Work Experience: Previous experience, the number of jobs held with the same or other employers, including the nature of duties, and responsibilities and the duration of various assignments, salary received, grades, and reasons for leaving the present employer.

(d) Salary and Benefits: Present and expected.

(e) Other Items: Names and addresses of previous employers, references, etc. An application blank is a brief history sheet of an employee's background and can be used for future reference, in case needed.

The application blank must be designed from the viewpoint of the applicant as well as with the company's purpose in mind. It should be relatively easy to handle in the employment office. Application form helps to serve many functions like:

- Its main usefulness is to provide information for reference checking, good interviewing, and correlation with testing data.
- It helps to weed out candidates who are lacking in education, experience or some other eligibility traits.
- It helps in formulating questions to be asked in the interview.
- Data contained in application form can be stored for future reference.
- It also tests the candidate's ability to write, to organize his thoughts, and to present facts clearly and succinctly.
- It indicates further whether the applicant has consistently progressed to better jobs. It provides factual information.

Weighted Application Blanks

Some organisations assign numeric values or weights to the responses provided by the applicants. This makes the application form more job related. Generally, the items that have a strong relationship to job performance are given higher scores. For example, for a sales representative's position, items such as previous selling experience, area of specialisation, commission earned, religion, language etc. The total score of each applicant is then obtained by adding the weights of the individual item responses. The resulting scores are then used in the final selection. WAB is best suited for jobs where there are many employees especially for sales and technical jobs. It can help in reducing the employee turnover later on. However, there are several problems associated with WAB e.g.

- It takes time to develop such a form.
- The WAB would have to be updated every few years to ensure that the factors previously identified are still valid products of job success.
- The organisation should be careful not to depend on weights of a few items while finally selecting the employee.

4. Selection Tests: Many organisations hold different kinds of selection tests to know more about the candidates or to reject the candidates who cannot be called for interview etc. Selection tests normally supplement the information provided in the application forms. Such forms may contain factual information about candidates. Selection tests may give information about their aptitude, interest, personality, which cannot be known by application forms. Types of tests and rules of good of testing have been discussed in brief below:

- A. Aptitude Tests:** These measure whether an individual has the capacity or talent ability to learn a given job if given adequate training. These are more useful for clerical and trade positions.
- B. Personality Tests:** At times, personality affects job performance. These determine personality traits of the candidate such as cooperativeness, emotional balance etc. These seek to assess an individual's motivation, adjustment to the stresses of everyday life, capacity for interpersonal relations and self-image.
- C. Interest Tests:** These determine the applicant's interests. The applicant is asked whether he likes, dislikes, or is indifferent to many examples of school subjects, occupations, amusements, peculiarities of people, and particular activities.

- D. Performance Tests:** In this test the applicant is asked to demonstrate his ability to do the job. For example, prospective typists are asked to type several pages with speed and accuracy.
- E. Intelligence Tests:** This aim at testing the mental capacity of a person with respect to reasoning, word fluency, numbers, memory, comprehension, picture arrangement, etc. It measures the ability to grasp, understand and to make judgement.
- F. Knowledge Tests:** These are devised to measure the depth of the knowledge and proficiency in certain skills already achieved by the applicants such as engineering, accounting etc.
- G. Achievement Tests:** Whereas aptitude is a capacity to learn in the future, achievement is concerned with what one has accomplished. When applicants claim to know something, an achievement test is given to measure how well they know it.
- H. Projective Tests:** In these tests the applicant projects his personality into free responses about pictures shown to him which are ambiguous.

Rules of Good Testing

- Norms should be developed for each test. Their validity and reliability for a given purpose should be established before they are used.
- Adequate time and resources must be provided to design, validate, and check tests.
- Tests should be designed and administered only by trained and competent persons.
- The user of tests must be extremely sensitive to the feelings of people about tests.
- Tests are to be uses as a screening device.
- Reliance should not be placed solely upon tests in reaching decisions.
- Tests should minimize the probabilities of getting distorted results. They must be 'race-free'.
- Tests scores are not precise measures. They must be assigned a proper weightage.

5. Interview: An interview is a procedure designed to get information from a person and to assess his potential for the job he is being considered on the basis of oral responses by the applicant to oral inquiries by the interviewer. Interviewer does a formal in-depth conversation with the applicant, to evaluate his suitability. It is one of the most important tools in the selection process. This tool is used when interviewing skilled, technical, professional and even managerial employees. It involves two-way exchange of information. The interviewer learns about the applicant and the candidate learns about the employer.

Objectives of Interviews: Interview helps:

- To obtain additional information from the candidate.
- Facilitates giving to the candidate information about the job, company, its policies, products etc.
- To assess the basic suitability of the candidate.

The selection interview can be:

- One to one between the candidate and the interviewer:
- Two or more interviewers by employers representatives-sequential;
- By a panel of selections, i.e., by more than representative of the employer.

The sequential interview involves a series of interviews; each interviewer meeting the candidate separately. The panel interview consists of two or more interviews meeting the candidate together.

Types of interviews: Interviews can be classified in various ways according to:

- (A) Degree of Structure
- (B) Purpose of Interview
- (C) Content of Interview

(A) Degree of Structure:

(1) Unstructured or non directive: in which you ask questions as they come to mind. There is no set format to follow.

(2) Structured or directive: in which the questions and acceptable responses are specified in advance. The responses are rated for appropriateness of content.

Structured and non-structured interviews have their pros and cons. In structured interviews all applicants are generally asked all required questions by all interviewers. Structured interviews are generally more valid. However structured interviews do not allow the flexibility to pursue points of interests as they develop.

(B) Purpose of Interview: A selection interview is a type of interview designed to predict future job performance, on the basis of applicant's responses to the oral questions asked to him.

A stress interview is a special type of selection interview in which the applicant is made uncomfortable by series of awkward and rude questions. The aim of stress interview is supposedly to identify applicant's low or high stress tolerance. In such an interview the applicant is made uncomfortable by throwing him on the defensive by series of frank and often discourteous questions by the interviewer.

(C) Content of Interview: The content of interview can be of a type in which individual's ability to project a situation is tested. This is a situation type interview. **In job-related interview**, interviewer attempts to assess the applicant's past behaviours for job related information, but most questions are not considered situational.

In a behaviour interview a situation is described and candidates are asked how they behaved in the past in such a situation. While in **situational interviews** candidates are asked to describe how they would react to situation today or tomorrow. In the behavioural interview they are asked to describe how they did react to the situation in the past.

Principles of Interviewing

To make it effective, an interview should be properly planned and conducted on certain principles; Edwin B. Flipbo has described certain rules and principles of good interviewing to this end:

- Provide proper surroundings. The physical setting for the interview should be both private and comfortable.
- The mental setting should be one of rapport. The interviewer must be aware of non-verbal behaviour.
- Plan for the interview by thoroughly reviewing job specifications and job descriptions.
- Determine the specific objectives and the method of the interviewing.
- Inform yourself as much as possible concerning the known information about the interviewee.
- The interviewer should possess and demonstrate a basic liking and respect for people.
- Questions should be asked in a manner that encourages the interviewee to talk. Put the applicant at ease.
- Make a decision only when all the data and information are available. Avoid decisions that are based on first impressions.
- Conclude the interview tactfully, making sure that the candidate leaves feeling neither too elated nor frustrated.
- Maintain some written record of the interview during or immediately after it.
- Listen attentively and, if possible, protectively.

- Questions must be stated clearly to avoid confusion and ambiguity. Maintain a balance between open and overtly structured questions.
- 'Body language' must not be ignored.
- The interviewer should make some overt sign to indicate the end of the interview.

Interviewing is largely an art, the application of which can be improved through practice.

6. Background Investigation: The next step in the selection process is to undertake an investigation of those applicants who appear to offer potential as employees. This may include contacting former employers to confirm the candidate's work record and to obtain their appraisal of his or her performance/ contacting other job-related and personal references, and verifying the educational accomplishments shown on the application.

The background investigation has major implications. Every personnel administrator has the responsibility to investigate each potential applicant. In some organization, failure to do so could result in the loss of his or her job. But many managers consider the background investigation data highly biased. Who would actually list a reference that would not give anything but the best possible recommendation? The seasoned personnel administrator expects this and delves deeper into the candidate's background, but that, too, may not prove to be beneficial. Many past employers are reluctant to give any information to another company other than factual information (e.g., date of employment).

Even though there is some reluctance to give this information, there are ways in which personnel administrators can obtain it. Sometimes, for instance information can be obtained from references once removed. For example, the personnel administrator can ask a reference whose name has been provided on the application form to give another reference, someone who has knowledge of the candidate's work experience. By doing this, the administrator can eliminate the possibility of accepting an individual based on the employee's current employer's glowing recommendation when the motivation for such a positive recommendation was to get rid of the employee.

7. Physical Examination: After the selection decision and before the job offer is made, the candidate is required to undergo physical fitness test. Candidates are sent for physical examination either to the company's physician or to a medical officer approved for the purpose. Such physical examination provides the following information.

- Whether the candidate's physical measurements are in accordance with job requirements or not?
- Whether the candidate suffers from bad health which should be corrected?
- Whether the candidate has health problems or psychological attitudes likely to interfere with work efficiency or future attendance?
- Whether the candidate is physically fit for the specific job or not?

Policy on these physical exams has changed today. Dale Yoder writes, "Modern policy used the physical examination not to eliminate applicants, but to discover what jobs they are qualified to fill. The examination should disclose the physical characteristics of the individual that are significant from the standpoint of his efficient performance of the job he may enter or of those jobs to which he may reasonably expect to be transferred or promoted. It should note deficiencies, not as a basis for rejection, but as indicating restrictions on his transfer to various positions also."

8. Approval by Appropriate Authority: On the basis of the above steps, suitable candidates are recommended for selection by the selection committee or personnel department. Though such a committee or personnel department may have authority to select the candidates finally, often it has staff authority to recommend the candidates for selection to the appropriate authority. Organisations may designate the

MANAGEMENT

various authorities for approval of final selection of candidates for different categories of candidates. Thus, for top level managers, board of directors may be approving authority; for lower levels, even functional heads concerned may be approving authority.

9. Final Employment Decision: After a candidate is finally selected, the human resource department recommends his name for employment. The management or board of the company offers employment in the form of an appointment letter mentioning the post, the rank, the salary grade, the date by which the candidate should join and other terms and conditions of employment. Some firms make a contract of service on judicial paper. Usually an appointment is made on probation in the beginning. The probation period may range from three months to two years. When the work and conduct of the employee is found satisfactory, he may be confirmed. The personnel department prepare a waiting list and informs the candidates. In case a person does not join after being selected, the company calls next person on the waiting list.

10. Evaluation: The selection process, if properly performed, will ensure availability of competent and committed personnel. A period audit, conducted by people who work independently of the human resource department, will evaluate the effectiveness of the selection process. The auditors will do a thorough and the intensive analysis and evaluate the employment programme.

2.6 INDUCTION:

Induction - the process of familiarisation with the organisation and settling into the job. It is easy to forget that the selection process is only the beginning of the employment relationship, and the future of that relationship depends to a considerable extent on how the new employee is settled into the job. Most labour turnover is among new employees, and work efficiency is reached only after a period of learning and adjusting to the new environment.

By planning an induction programme, in consultation with trade union or other employee representatives if available, the organisation can quickly build on the positive attitude of the successful candidate. However keen new recruits may be, they may have anxieties about how well they will:

- get on with their co-workers
- understand the standards and rules (written and unwritten) of the organisation
- make a good impression on their new manager or supervisor
- be able to do the job.

A good induction programme makes business sense, whatever the size of the organisation, and whatever the job. It introduces the newcomer not only to their immediate colleagues, but to other workers with whom they may have less day-to-day contact, including trade union representatives (if they are recognised in the organisation) or employee representatives on any staff committee or council.

2.6.1 The induction timetable

Induction often begins before the person has actually started, in that the organisation

MANAGEMENT

will

supply material as part of an initial 'information pack', or with the invitation to interview, or with the letter of job offer. This may be particularly important in jobs of a technical nature, where it

is helpful for the new starter to be as well informed as possible about that side of the work.

Clearly, learning the particular projects and initiatives will have to be done in the workplace but much 'mental preparedness' can be undertaken in advance. The Company Handbook, and the Written Statement of Employment Particulars, can also provide essential information about the organisation and the job.

A good reception, with the line or personnel manager spending time with the new employee, is important on the first day. There may be further documentation to complete, perhaps a preliminary discussion about training either immediately or in the future, an explanation of the development opportunities that are available, and of course enough information to give the new starter a good grasp of the working practices of the organisation. Any particular health and safety requirements should be made known, together with details of whom to go to for help and advice during the course of their employment. Many companies use a 'buddy' system, where an experienced worker is nominated to assist the new recruit in all the day-to-day questions that may arise.

It is useful to have a written checklist of the items that need to be covered in the induction programme; and an example of such a list is at [Appendix 1, 2 & 3](#). Not only does this give some structure to the induction but it also ensures that both the new starter and the manager know what has or has not been covered at any given time. Such a checklist is normally drawn up by the personnel section in consultation with other involved staff, such as safety officers, line manager/supervisors, employee representatives (if appropriate), and training officers.

The induction programme may be spread over several days or weeks, and may incorporate specific job training, but the following points should be borne in mind:

- all employees need to be able to work in a safe and healthy manner. Recruitment and placement procedures should ensure that employees (including managers) have the necessary physical and mental abilities to do their jobs, or can acquire them through training and experience. Employers should have systems in place to identify health and safety training needs arising from recruitment
- people can take in only so much information at any given time, and should not be overloaded. It is important that health and safety is introduced in a structured way

MANAGEMENT

- if there are special health and safety requirements, make sure the new starter fully understands their importance - otherwise there is the risk of being exposed to unnecessary danger or endangering their co-workers. All employees must know what to do in the event of a fire or other emergency
- setting out the plan of induction at the beginning avoids the problems that can arise in trying to arrange time in the future, when the employee is established in the job
- don't forget induction needs for shift workers or night workers. They may need some time on days, or modified shifts, to cover the induction period
- even if the induction period covers job training, try to let new starters do some practical work, as this will assist their learning and enable them to relate what they are being taught to what they will be doing.

The outcome of all this is that the new starter should have a good feel for the organisation, and should continue to feel that they made the right decision in joining the firm.

2.6.2 The induction process

Induction need not be a very formal process but it needs to be properly managed. In many organisations it will be carried out informally by the new starter's manager or supervisor on a day-to-day basis. Nevertheless, having a structured checklist to follow is useful for both parties. Most induction will consist of meeting and talking with new colleagues, watching activities and asking questions. It may be appropriate to provide certain information in written form; and if the organisation has a company handbook, this can often act as an aide memoire covering important aspects of the company organisation and how it functions.

If a group of new employees is recruited at the same time, it may make sense to hold group induction sessions on the common topics to be covered - discussion, videos, slide presentations can all add to the effectiveness of the programme.

Even people transferring from one part of the organisation to another need induction into their new area. Don't assume that they will know the relevant people or the skills they will need in the new job. However, they may need a more individually tailored induction programme to meet their particular needs.

Employees who may need special attention

The new starter who has considerable recent work experience and is a confident, outgoing individual may have a different induction need from the person with little or no experience, and who may be shy or reserved in this new work setting.

School and college leavers

For school or college leavers, who may be nervous but excited at their first job, it is particularly important for the employer to encourage a positive attitude to work, and to allay any fears the new recruit may have. They need to be sure of their position in the company, and of the opportunities they will have to train and develop their skills.

Health and safety is a particularly important area to stress. Young people often have no feel for workplace hazards, and may be vulnerable to accidents. A group of young people together may get high spirited and, without proper guidance on safety, be unaware of the potential dangers. Young workers are seen as being particularly at risk, and employers are required to:

- assess risks to young people under 18, before they start work.
- take into account their inexperience, lack of awareness of existing or potential risks, and immaturity
- address specific factors in the risk assessment.

Employers are required to make a suitable and sufficient assessment of the risks to the health and safety of employees and identify groups of workers who might be particularly at risk.

People returning to work after a break in employment, or changing their work situation

Men or women returning to work after some years caring for children or other relatives may feel apprehensive about the new job - even when they may have worked for the company in the past. They may feel out of touch with developments, and in need of re-establishing themselves. Their induction programme needs to take this into account, offering training and extra help to settle in and become valuable members of the organisation.

This is also true of those who might have been living/working abroad, or who are changing their career focus.

Employees with disabilities

Careful pre-planning can reduce the problems which may arise for employees with disabilities, whether in terms of access, equipment or dealing with colleagues. Specialist advice is available from the Disability Employment Adviser and the Disability Service Teams of the Department for Work and Pensions. The Department for Work and Pensions also operates the Access to Work Scheme, whereby assistance may be available in meeting the cost of any aids and adaptations required. These services can be contacted via the JobCentre network.

Management/professional trainees

Commonly, management and professional trainees are not recruited for specific jobs but undergo further education and training after their employment commences. This may mean they are less able to be involved with practical work, and without care this can lead to a loss of interest and motivation. Their induction period should attempt to include them in appropriate work in the organisation if at all possible.

Minorities

They should have the same induction programme as any other new starter, but attention should be paid to any sensitivities. Employers may need to be aware and take account of any particular cultural or religious customs of new employees who are part of an ethnic or religious minority so that misunderstandings do not occur.

Acas' Equality Service can assist employers with free advice on the development and implementation of policies and practices for greater equality among the workforce.

Who is responsible for the induction process?

There may well be several people involved in the planning and delivery of the induction programme. In a small company it may be the personnel officer, the manager or supervisor, and perhaps a 'buddy'. A larger organisation may call on the abilities and skills of many people. These could include:

- the personnel or human resource manager. Their likely involvement would be to

Go over the terms and conditions, complete any necessary paperwork, and perhaps give an overview of the company organisation

- a competent health and safety adviser, particularly if there is a need for specific safety procedures or protective clothing, etc. This person assists an employer in applying the

provisions of health and safety law.

- the training officer
- the line or department manager. This person will normally provide the more local welcome to the organisation, explaining where that particular department or section fits with the whole, and providing the first round of introductions to the department
- the supervisor, who will have the greatest responsibility and interest in getting the new starter settled in and effective as soon as possible. This is generally where the use of a checklist can best be made, with the supervisor able to check easily what has been covered, what needs to be done, and any particular points that may need further explanation
- the trade union or employee representative, and safety representative, to explain their role.

It is often useful to have a co-worker to act as a guide and adviser to the new recruit, even if the organisation does not have a formal 'buddy' system. This person can help in those everyday questions such as canteen facilities, introducing other co-workers, explaining the layout of the building, etc in an informal way as they occur. This process can also be a good way of providing a development opportunity to the person who acts as guide and mentor.

Try to follow up the new employee after a suitable period, perhaps six months, to check that the induction went well. This could be part of a general review for the individual.

Monitoring effectiveness

As with any work activity it is recommended that the recruitment and induction process be reviewed for its effectiveness. If any stage of the recruitment process failed to produce the expected result, eg if the advertising method has produced too many candidates, you may want to examine what happened and why in order to make it more efficient in the future. Future recruitment exercises may require modifications to the methods used - a successful recruitment for one job does not automatically mean the same method will be as successful again. This is particularly true if the labour market changes, with, for instance, fewer school leavers but more mature workers being available.

Recruitment and induction may be a continuous process in your organisation, necessitating more or less constant monitoring.

Monitoring regularly will also ensure equal opportunity policies are being actively pursued, and that internal candidates are receiving the same consideration as external candidates.

It is the process of inducting or orienting a new employee into the social setting of his work.

Steps:

- i) Familiarising the new employee with his new surroundings and company rules & regulations.
- ii) Integrating his personal goals with the organization goals.

2.7 Socialization

In order to reduce the anxiety that new employees may experience, attempts should be made to integrate

the person into the informal organization. The initial T&D effort designed for employees is Socialization,

the guided adjustment of new employees to the company, the job, and the work group.

I. Purposes of Socialization

Socialization formats are unique to each firm. However, some basic purposes include emphasizing these areas: the employment situation (job, department, and company), company policies and rules, compensation

and benefits, corporate culture, team membership, employee development, dealing with change, and socialization.

a. The Employment Situation

A basic purpose, from the firm's viewpoint, is to have the new employee become productive as quickly as possible. Therefore, specific information about performing the job may be provided at an early point in time.

b. Company Policies and Rules

Every job within an organization must be performed considering the guidelines and constraints provided by policies and rules. Employees must have an understanding of these to permit a smooth transition to the workplace.

c. Compensation and Benefits

Employees will have a special interest in obtaining information about the reward system. Although this information is usually provided during the recruitment and selection process, a review of the data is appropriate during Socialization.

d. Corporate Culture

The firm's culture reflects, in effect, how we do things around here. This relates to everything from the way employees dress to the way they talk.

e. Team Membership

A new employee's ability and willingness to work in teams is most likely determined before he or she is hired. In Socialization, the importance of becoming a valued member of the company team may be emphasized.

f. Employee Development

Employees should know exactly what is expected of them and what is required by the firm for advancement in the job or via promotion.

g. Dealing With Change

Employees at all levels must learn to effectively deal with change in order to survive in their jobs. The best way individuals can be prepared for change is to continually develop and expand their skills.

h. Socialization

In order to reduce the anxiety that new employees may experience, attempts should be made to integrate the person into the informal organization.

2.7.1 Stages in socialization Process:

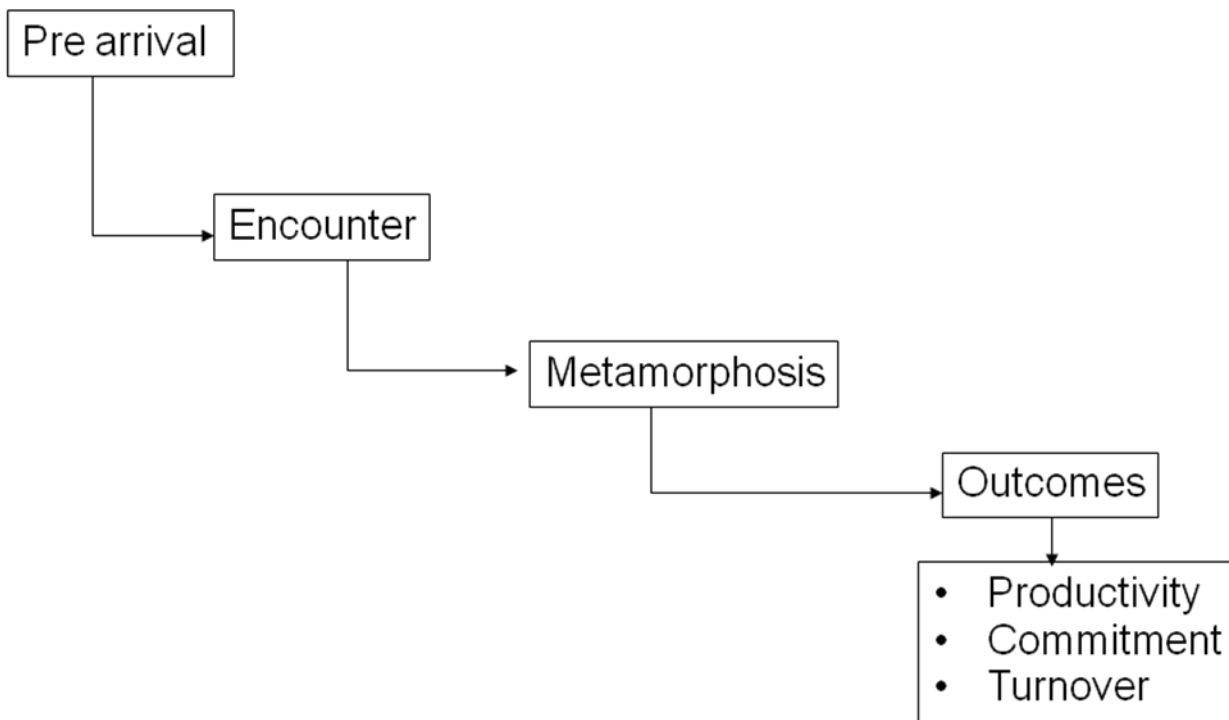

Socialization can be conceptualized as a process made up of three stages.

a. Pre-arrival Stage:

This stage explicitly recognizes that each individual arrives with a set of organizational values, attitudes, and expectations. For instance, in many jobs, particularly high skilled and managerial jobs, new members will have undergone a considerable degree of prior socialization in training and in school. Pre-arrival socialization, however, goes beyond the specific job. The selection process is used in most organizations to inform prospective employees about the organization as whole. In addition, of course, interviews in the selection process also act to ensure the inclusion of the “right type” determining those who will fit in. Indeed, the ability of the individuals to present the appropriate face during the selection process determines their ability to move into the organization in the first place. Thus success depends upon the degree to which aspiring members have correctly anticipated the expectations and desires of those in the organization in charge of selection.

b. Encounter Stage:

Upon entry into the organization, new members enter the encounter stage. Here the individuals confront the possible dichotomy between their expectations about their jobs, their coworkers, their supervisors, and the organization in general and reality. If expectations prove to have been more or

less accurate, the encounter state merely provides a reaffirmation of the perceptions generated earlier. However, this is often not the case. Where expectation and reality differ; new employees must undergo socialization that will detach them from their previous assumption and replace these with the organization's pivotal standards. Socialization, however, cannot solve all the expectation differences. At the extreme, some new members may become totally disillusioned with the actualities of their jobs and resign. It is hoped that proper selection would significantly reduce this latter occurrence.

c. Metamorphosis Stage:

Finally the new member must work out any problems discovered during the encounter stage. This may mean going through changes. Hence the last stage is termed as metamorphosis stage. Metamorphosis is complete as is the socialization process – when new members have become comfortable with the organization and their work teams. In this situation they will have internalized the norms of the organization and their coworkers; and they understand and accept these norms. New members will feel accepted by their peers as trusted and valued individuals. They will have gained an understanding of the organizational system- not only their own tasks but the rules, procedures and informally accepted practices as well. Finally they will know how they are going to be evaluated. They will know what is expected of them and what constitutes a good job. Consequently, successful metamorphosis should have positive effect on a new employees productivity and the employee's commitment to the organization, and should reduce the likelihood that the employee will leave the organization any time soon.

III. Many People Socialize new Hires

New employee socialization or orientation covers the activities involved in introducing a new employee to the organization and to his or her work unit. How is responsible for the orientation of new employee? This can be done by the supervisor, the people in HRM, Peers, CEO, or combination of any of these.

a. **HRM Department:** HRM department can conduct the orientation in order to socialize the newly hired employees with the working environment of the organization. HRM plays a major role in new employee orientation-the role of coordination, which ensures that the appropriate components are in place. In addition HRM also serves as a participant in program. As job offers are made and accepted, HRM should instruct the new employee when to report to work. However, before the employee formally arrives, HRM must be prepared to handle some of the more routine needs of these individuals.

b. **Supervisor:** Immediate supervisor of particular department can also be the source of informing the employees about the culture, rules, procedures and policies of the organization. Mostly in smaller organizations, orientation may mean the new member reports to supervisor, who then assigns the new member to other employee who will introduce the new member to other coworkers. This may be followed by a quick tour to show the different parts and departments of the organization.

c. **Peers:** Peers and coworkers of the new hires can perform the orientation function in order to tell the expectation of employers and requirements of the organization as can also answer the queries raised from the employee side.

d. **Organizational culture:** Organizational culture itself can express the do's and don'ts of any organization. Every organization has its own unique culture. This culture includes longstanding, and often unwritten, rules and regulation; a special language that facilitates communication among members; shared standards of relevance as to the critical aspects of the work that is to be done;

standards for social etiquette, customs for how members should relate to peers, employees, bosses and outsiders; what is appropriate and smart behavior with in organization and what is not.

e. **CEO:** Prior to mid 1980s, new employee orientation operated, if at all, with out any output from the company's executive management. But that began to change, due in part to management consultants advocating that senior management become more accessible to employees. The CEO's first responsibility is to welcome new employees aboard and talk to them about what a good job choice they made. The CEO is in position to inspire these new employees by talking about what it is like to work for the organization. When CEO is present in the socialization process, the company is sending a message that it truly cares for its employees.

IV. Employee Orientation program:

Orientation or socialization process.

a. **Introduction:** Regarding the organization, supervisor, trainers, and coworkers and to system

b. **Job Duties:** It provides job related information like, Job location Job tasks Job safety requirements Overview of job, Job objectives Relationship to other jobs

c. **Organizational Issues:** This provides the information about the overall organization it may include; History of employer, organization of employer, name & titles of key executive, employee's titles and departments, layout of physical facilities, probationary period, overview of production process, company policies and rules, disciplinary regulations, employee handbook, safety procedures etc

d. **Employee Benefits:** This part provides the information about the benefits that are offered by the organization like; Pay scales & paydays, vacations rest break, training & education benefits, counseling, housing facilities, insurance benefits, retirement program, employee-provided services for employees, rehabilitation program

The Hiring Process

Hiring process is completed here because orientation or the socialization process is the last step of hiring.

B. Training

Training is a process whereby people acquire capabilities to aid in the achievement of organizational goals. It involves planned learning activities designed to improve an employee's performance at her/his current job. Training refers to the methods used to give new or present employees the skills they need to perform their jobs.

C. Development

All efforts to provide employees with the abilities the organizations will need in the future

D. Training and Development Trends:

- Skill requirements will continue to increase
- Workforce will become significantly better educated & more diverse
- Corporate restructuring reshapes businesses
- Technology will revolutionize certain training delivery methods
- The role of training departments will change

- More flexible courses aimed specifically at performance improvement
- More firms will strive to become learning organizations
- Emphasis on human performance management will accelerate.

Methods of socialisation

- Stories
- Rituals
- Material symbols
- Language

Socialisation benefits

- Helps in understanding organisation culture
- Contributes to employee's long term success
- Helps in adjustment
- Helps in employee engagement
- Provides job satisfaction.

CHAPTER III

TRAINING AND EXECUTIVE DEVELOPMENT

3.1 Training is a process of learning a sequence of programmed behavior. It is the application of knowledge & gives people an awareness of rules & procedures to guide their behavior. It helps in bringing about positive change in the knowledge, skills & attitudes of employees.

Thus, training is a process that tries to improve skills or add to the existing level of knowledge so that the employee is better equipped to do his present job or to mould him to be fit for a higher job involving higher responsibilities. It bridges the gap between what the employee has & what the job demands.

Training refers to a planned effort by a company to facilitate employees' learning of job related competencies. These competencies include knowledge, skills, or behaviors that are critical for successful job performance. The goal of training is for employees to master the knowledge, skill, and behaviors emphasized in training programs and to apply them to their day to day activities. Training is seen as one of several possible solutions to improve performance. Other solutions can include such actions as changing the job or increasing employee motivation through pay and incentives. Today there is a greater emphasis on-

- Providing educational opportunities for all employees. These educational opportunities may include training programs, but they also include support for taking courses offered outside the company, self-study, and learning through job rotation.
- An ongoing process of performance improvement that is directly measurable rather than organizing one time training events.
- The need to demonstrate to executives, managers, and trainees the benefits of training.
- Learning as a lifelong event in which senior management, trainer manager, and employees have ownership.

- Training being used to help attain strategic business objectives, which help companies, gains a competitive advantage.

The term **training** refers to the acquisition of knowledge, skills, and competencies as a result of the teaching of vocational or practical skills and knowledge that relate to specific useful competencies. It forms the core of apprenticeships and provides the backbone of content at institutes of technology (also known as technical colleges or polytechnics). In addition to the basic training required for a trade, occupation or profession, observers of the labor-market recognize as of 2008^[update] the need to continue training beyond initial qualifications: to maintain, upgrade and update skills throughout working life. People within many professions and occupations may refer to this sort of training as professional development.

Training usually refers to some kind of organized (and finite it time) event — a seminar, workshop that has a specific beginning data and end date. It's often a group activity, but the word training is also used to refer to specific instruction done one on one.

Employee development, however, is a much bigger, inclusive “thing”. For example, if a manager pairs up a relatively new employee with a more experienced employee to help the new employee learns about the job, that's really employee development. If a manager coaches and employee in an ongoing way, that's employee development. Or, employees may rotate job responsibilities to learn about the jobs of their colleagues and gain experience so they might eventually have more promotion opportunities. That's employee development.

3.1.1 TRAINING AND DEVELOPMENT OBJECTIVES

The principal objective of training and development division is to make sure the availability of a skilled and willing workforce to an organization. In addition to that, there are four other objectives: Individual, Organizational, Functional, and Societal. Training and development is a subsystem of an organization. It ensures that randomness is reduced and learning or behavioural change takes place in structured format.

Individual Objectives – help employees in achieving their personal goals, which in turn, enhances the individual contribution to an organization.

Organizational Objectives – assist the organization with its primary objective by bringing individual effectiveness.

Functional Objectives – maintain the department's contribution at a level suitable to the organization's needs.

Societal Objectives – ensure that an organization is ethically and socially responsible to the needs and challenges of the society.

The quality of employees and their development through training and education are major factors in determining long-term profitability of a small business. If you hire and keep good employees, it is good policy to invest in the development of their skills, so they can increase their productivity.

Training often is considered for new employees only. This is a mistake because ongoing training for current employees helps them adjust to rapidly changing job requirements. Reasons for emphasizing the growth and development of personnel include

- Creating a pool of readily available and adequate replacements for personnel who may leave or move up in the organization.
- Enhancing the company's ability to adopt and use advances in technology because of a sufficiently knowledgeable staff.
- Building a more efficient, effective and highly motivated team, which enhances the company's competitive position and improves employee morale.
- Ensuring adequate human resources for expansion into new programs.

3.1.2 BENEFITS:

Research has shown specific benefits that a small business receives from training and Developing its workers, including:

- Increased productivity.
- Reduced employee turnover.
- Increased efficiency resulting in financial gains.
- Decreased need for supervision.

Employees frequently develop a greater sense of self-worth, dignity and well-being as they become more valuable to the firm and to society. Generally they will receive a greater share of the material gains that result from their increased productivity. These factors give them a sense of satisfaction through the achievement of personal and company goals.

3.1.3 Need for Employee Training

Training of employees takes place after orientation takes place. Training is the process of enhancing the skills, capabilities and knowledge of employees for doing a particular job. Training process moulds the thinking of employees and leads to quality performance of employees. It is continuous and never ending in nature.

Training is given on four basic grounds:

1. New candidates who join an organization are given training. This training familiarizes them with the organizational mission, vision, rules and regulations and the working conditions.
2. The existing employees are trained to refresh and enhance their knowledge.
3. If any updates and amendments take place in technology, training is given to cope up with those changes. For instance, purchasing new equipment, changes in technique of production, computer impartment. The employees are trained about use of new equipments and work methods.
4. When promotion and career growth becomes important. Training is given so that employees are prepared to share the responsibilities of the higher level job.

Training needs can be assessed by analyzing three major human resource areas: the organization as a whole, the job characteristics and the needs of the individuals. This analysis will provide answers to the following questions:

- Where is training needed?
- What specifically must an employee learn in order to be more productive?
- Who needs to be trained?

Begin by assessing the current status of the company how it does what it does best and the abilities of your employees to do these tasks. This analysis will provide some benchmarks against which the effectiveness of a training program can be evaluated. Your firm should know where it wants to be in five years from its long-range strategic plan. What you need is a training program to take your firm from here to there.

Second, consider whether the organization is financially committed to supporting the training efforts. If not, any attempt to develop a solid training program will fail.

Next, determine exactly where training is needed. It is foolish to implement a companywide training effort without concentrating resources where they are needed most. An internal audit will help point out areas that may benefit from training. Also, a skills inventory can help determine the skills possessed by the employees in general. This inventory will help the organization determine what skills are available now and what skills are needed for future development.

Also, in today's market-driven economy, you would be remiss not to ask your customers what they like about your business and what areas they think should be improved. In summary, the analysis should focus on the total organization and should tell you (1) where training is needed and (2) where it will work within the organization. Once you have determined where training is needed, concentrate on the content of the program. Analyze the characteristics of the job based on its description, the written narrative of what the employee actually does. Training based on job descriptions should go into detail about how the job is performed on a task-by-task basis. Actually doing the job will enable you to get a better feel for what is done. Individual employees can be evaluated by comparing their current skill levels or performance to the organization's performance standards or anticipated needs.

3.1.4 Importance

Training is crucial for organizational development and success. It is fruitful to both employers and employees of an organization. An employee will become more efficient and productive if he is trained well. The benefits of training can be summed up as:

1. **Improves Morale of Employees-** Training helps the employee to get job security and job satisfaction. The more satisfied the employee is and the greater is his morale, the more he will contribute to organizational success and the lesser will be employee absenteeism and turnover.
2. **Less Supervision-** A well trained employee will be well acquainted with the job and will need less of supervision. Thus, there will be less wastage of time and efforts.
3. **Fewer Accidents-** Errors are likely to occur if the employees lack knowledge and skills required for doing a particular job. The more trained an employee is, the less are the chances of committing accidents in job and the more proficient the employee becomes.
4. **Chances of Promotion-** Employees acquire skills and efficiency during training. They become more eligible for promotion. They become an asset for the organization.
5. **Increased Productivity-** Training improves efficiency and productivity of employees. Well trained employees show both quantity and quality performance. There is less wastage of time, money and resources if employees are properly trained.

Types of Employee Training

Some commentators use a similar term for workplace learning to improve performance: "training and development". One can generally categorize such training as on-the-job or off-the-job:

- On-the-job training takes place in a normal working situation, using the actual tools, equipment, documents or materials that trainees will use when fully trained. On-the-job training has a general reputation as most effective for vocational work.
- Off-the-job training takes place away from normal work situations — implying that the employee does not count as a directly productive worker while such training takes place. Off-the-job training has the advantage that it allows people to get away from work and concentrate more

thoroughly on the training itself. This type of training has proven more effective in inculcating concepts and ideas.

The most frequently used method in smaller organizations that is on the job training. This method of training uses more knowledgeable, experienced and skilled employees, such as managers, supervisors to give training to less knowledgeable, skilled, and experienced employees. OJT can be delivered in classrooms as well. This type of training often takes place at the work place in informal manner.

On the Job Training is characterized by following points

- It is done on ad-hoc manner with no formal procedure, or content
- At the start of training, or during the training, no specific goals or objectives are developed
- Trainers usually have no formal qualification or training experience for training
- Training is not carefully planned or prepared
- The trainer are selected on the basis of technical expertise or area knowledge

Formal OJT programs are quite different from informal OJT. These programs are carried out by identifying the employees who are having superior technical knowledge and can effectively use one-to-one interaction technique. The procedure of formal on the job training program is:

1. The participant observes a more experienced, knowledgeable, and skilled trainer (employee)
2. The method, process, and techniques are well discussed before, during and after trainer has explained about performing the tasks
3. When the trainee is prepared, the trainee starts performing on the work place
4. The trainer provides continuing direction of work and feedback
5. The trainee is given more and more work so that he accomplishes the job flawlessly

The four techniques for on the job development are:

- COACHING
- MENTORING
- JOB ROTATION
- JOB INSTRUCTION TECHNIQUE (JIT)

1.) Coaching is one of the training methods, which is considered as a corrective method for inadequate performance. According to a survey conducted by International Coach Federation (ICF), more than 4,000 companies are using coach for their executives. These coaches are experts most of the time outside consultants.

A coach is the best training plan for the CEO's because

- It is one to one interaction
- It can be done at the convenience of CEO
- It can be done on phone, meetings, through e-mails, chat
- It provides an opportunity to receive feedback from an expert
- It helps in identifying weaknesses and focus on the area that needs improvement

This method best suits for the people at the top because if we see on emotional front, when a person reaches the top, he gets lonely and it becomes difficult to find someone to talk to. It helps in finding out the executive's specific developmental needs. The needs can be identified through 60 degree performance reviews.

Procedure of the Coaching

The procedure of the coaching is mutually determined by the executive and coach. The procedure is followed by successive counseling and meetings at the executive's convenience by the coach.

1. Understand the participant's job, the knowledge, skills, and attitudes, and resources required to meet the desired expectation
2. Meet the participant and mutually agree on the objective that has to be achieved
3. Mutually arrive at a plan and schedule
4. At the job, show the participant how to achieve the objectives, observe the performance and then provide feedback
5. Repeat step 4 until performance improves

For the people at middle level management, coaching is more likely done by the supervisor; however experts from outside the organization are at times used for up and coming managers. Again, the personalized approach assists the manager focus on definite needs and improvement.

2.) Mentoring is an ongoing relationship that is developed between a senior and junior employee. Mentoring provides guidance and clear understanding of how the organization goes to achieve its vision and mission to the junior employee.

The meetings are not as structured and regular than in coaching. Executive mentoring is generally done by someone inside the company. The executive can learn a lot from mentoring. By dealing with diverse mentee's, the executive is given the chance to grow professionally by developing management skills and learning how to work with people with diverse background, culture, and language and personality types.

Executives also have mentors. In cases where the executive is new to the organization, a senior executive could be assigned as a mentor to assist the new executive settled into his role. Mentoring is one of the important methods for preparing them to be future executives. This method allows the mentor to determine what is required to improve mentee's performance. Once the mentor identifies the problem, weakness, and the area that needs to be worked upon, the mentor can advise relevant training. The mentor can also provide opportunities to work on special processes and projects that require use of proficiency.

Some key points on Mentoring

- Mentoring focus on attitude development
- Conducted for management-level employees
- Mentoring is done by someone inside the company
- It is one-to-one interaction
- It helps in identifying weaknesses and focus on the area that needs improvement

3.) For the executive, **job rotation** takes on different perspectives. The executive is usually not simply going to another department. In some vertically integrated organizations, for example, where the supplier is actually part of same organization or subsidiary, job rotation might be to the supplier to see how the business operates from the supplier point of view.

Learning how the organization is perceived from the outside broadens the executive's outlook on the process of the organization. Or the rotation might be to a foreign office to provide a global perspective. For managers being developed for executive roles, rotation to different functions in the company is regular carried out.

This approach allows the manager to operate in diverse roles and understand the different issues that crop up. If someone is to be a corporate leader, they must have this type of training. A recent study indicated that the single most significant factor that leads to leader's achievement was the variety of experiences in different departments, business units, cities, and countries.

An organized and helpful way to develop talent for the management or executive level of the organization is job rotation. It is the process of preparing employees at a lower level to replace someone at the next higher level. It is generally done for the designations that are crucial for the effective and efficient functioning of the organization.

Some of the major benefits of job rotation are:

- It provides the employees with opportunities to broaden the horizon of knowledge, skills, and abilities by working in different departments, business units, functions, and countries
- Identification of Knowledge, skills, and attitudes (KSAs) required
- It determines the areas where improvement is required
- Assessment of the employees who have the potential and caliber for filling the position

4.) Job Instruction Technique (JIT) uses a strategy with focus on knowledge (factual and procedural), skills and attitudes development.

JIT Consists of Four Steps:

Plan – This step includes a written breakdown of the work to be done because the trainer and the trainee must understand that documentation is must and important for the familiarity of work. A trainer who is aware of the work well is likely to do many things and in the process might miss few things. Therefore, a structured analysis and proper documentation ensures that all the points are covered in the training program. The second step is to find out what the trainee knows and what training should focus on. Then, the next step is to create a comfortable atmosphere for the trainees' i.e. proper orientation program, availing the resources, familiarizing trainee with the training program, etc.

Present – In this step, trainer provides the synopsis of the job while presenting the participants the different aspects of the work. When the trainer finished, the trainee demonstrates how to do the job and why is that done in that specific manner. Trainee actually demonstrates the procedure while emphasizing the key points and safety instructions.

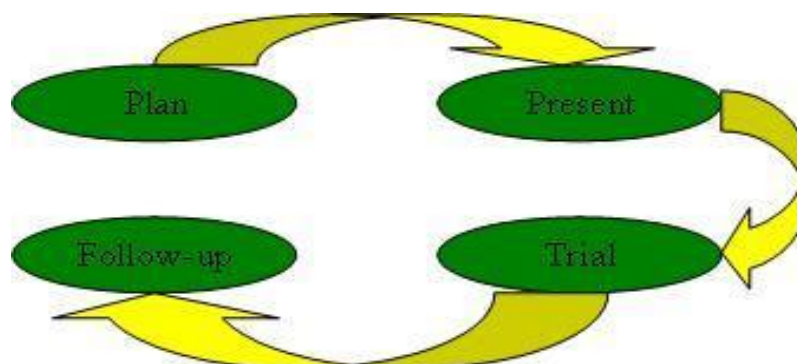

Figure 6.1 : Steps in JIT

Trial – This step actually a kind of rehearsal step, in which trainee tries to perform the work and the trainer is able to provide instant feedback. In this step, the focus is on improving the method of instruction because a trainer considers that any error if occurring may be a function of training not the trainee. This step allows the trainee to see the after effects of using an incorrect method. The trainer then helps the trainee by questioning and guiding to identify the correct procedure.

Follow-up – In this step, the trainer checks the trainee’s job frequently after the training program is over to prevent bad work habits from developing. There are various methods of training, which can be divided in to cognitive and behavioral methods. Trainers need to understand the pros and cons of each method, also its impact on trainees keeping their background and skills in mind before giving training.

OFF THE JOB TRAINING –

There are many management development techniques that an employee can take in off the job. The few popular methods are:

- SENSITIVITY TRAINING
- TRANSACTIONAL ANALYSIS
- STRAIGHT LECTURES/ LECTURES
- SIMULATION EXERCISES

1.) Sensitivity Training is about making people understand about themselves and others reasonably, which is done by developing in them social sensitivity and behavioral flexibility.

Social sensitivity in one word is empathy. It is ability of an individual to sense what others feel and think from their own point of view. Behavioral flexibility is ability to behave suitably in light of understanding.

Sensitivity Training Program requires three steps:

Unfreezing the Old Values –

It requires that the trainees become aware of the inadequacy of the old values. This can be done when the trainee faces dilemma in which his old values is not able to provide proper guidance. The first step consists of a small procedure:

- An unstructured group of 10-15 people is formed.
- Unstructured group without any objective looks to the trainer for its guidance
- But the trainer refuses to provide guidance and assume leadership
- Soon, the trainees are motivated to resolve the uncertainty
- Then, they try to form some hierarchy. Some try assume leadership role which may not be liked by other trainees
- Then, they started realizing that what they desire to do and realize the alternative ways of dealing with the situation



Figure 6.2 Procedure of Sensitivity Training

Development of New Values – With the trainer’s support, trainees begin to examine their interpersonal behavior and giving each other feedback. The reasoning of the feedbacks are discussed which motivates trainees to experiment with range of new behaviors and values. This process constitutes the second step in the change process of the development of these values.

Refreezing the new ones – This step depends upon how much opportunity the trainees get to practice their new behaviors and values at their work place.

2.) Transactional Analysis provides trainees with a realistic and useful method for analyzing and understanding the behavior of others. In every social interaction, there is a motivation provided by one person and a reaction to that motivation given by another person. This motivation reaction relationship between two persons is a transaction.

Transactional analysis can be done by the ego states of an individual. An ego state is a system of feelings accompanied by a related set of behaviors. There are basically three ego states:

Child: It is a collection of recordings in the brain of an individual of behaviors, attitudes, and impulses which come to her naturally from her own understanding as a child. The characteristics of this ego are to be spontaneous, intense, unconfident, reliant, probing, anxious, etc. Verbal clues that a person is operating from its child state are the use of words like “I guess”, “I suppose”, etc. and non verbal clues like, giggling, coyness, silent, attention seeking etc.

Parent: It is a collection of recordings in the brain of an individual of behaviors, attitudes, and impulses imposed on her in her childhood from various sources such as, social, parents, friends, etc. The characteristics of this ego are to be overprotective, isolated, rigid, bossy, etc. Verbal clues that a person is operating from its parent states are the use of words like, always, should, never, etc and non-verbal clues such as, raising eyebrows, pointing an accusing finger at somebody, etc.

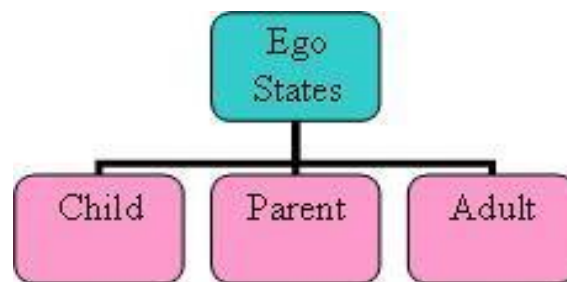

Figure 6.3

Adult: It is a collection of reality testing, rational behavior, decision making, etc. A person in this ego state verifies, updates the data which she has received from the other two states. It is a shift from the taught and felt concepts to tested concepts. All of us evoke behavior from one ego state which is responded to by the other person from any of these three states.

3.) Lecture is telling someone about something. Lecture is given to enhance the knowledge of listener or to give him the theoretical aspect of a topic. Training is basically incomplete without lecture. When the trainer begins the training session by telling the aim, goal, agenda, processes, or methods that will be used in training that means the trainer is using the lecture method. It is difficult to imagine training without lecture format. There are some variations in Lecture method. The variation here means that some forms of lectures are interactive while some are not.

Straight Lecture: Straight lecture method consists of presenting information, which the trainee attempts to absorb. In this method, the trainer speaks to a group about a topic. However, it does not involve any kind of interaction between the trainer and the trainees. A lecture may also take the form of printed text, such as books, notes, etc. The difference between the straight lecture and the printed material is the trainer’s intonation, control of speed, body language, and visual image of the trainer. The trainer in case of straight lecture can decide to vary from the training script, based on the signals from the trainees, whereas same material in print is restricted to what is printed. A good lecture consists of introduction of the topic,

purpose of the lecture, and priorities and preferences of the order in which the topic will be covered. Some of the main features of lecture method are:

- Inability to identify and correct misunderstandings
- Less expensive
- Can be reached large number of people at once
- Knowledge building exercise
- Less effective because lectures require long periods of trainee inactivity

4.) Games and Simulations are structured and sometimes unstructured, that are usually played for enjoyment sometimes are used for training purposes as an educational tool. Training games and simulations are different from work as they are designed to reproduce or simulate events, circumstances, processes that take place in trainees' job.

A Training Game is defined as spirited activity or exercise in which trainees compete with each other according to the defined set of rules. Simulation is creating computer versions of real-life games. Simulation is about imitating or making judgment or opining how events might occur in a real situation. It can entail intricate numerical modeling, role playing without the support of technology, or combinations. Training games and simulations are now seen as an effective tool for training because its key components are:

- Challenge
- Rules
- Interactivity

These three components are quite essential when it comes to learning. Some of the examples of this technique are:

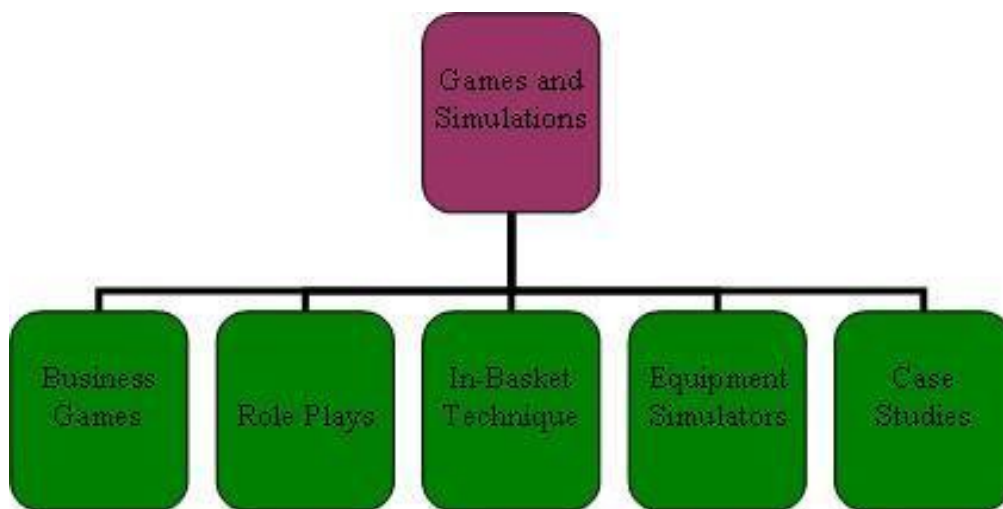

Figure 6.4

Trainees can therefore experience these events, processes, games in a controlled setting where they can develop knowledge, skills, and attitudes or can find out concepts that will improve their performance. The various methods that come under Games and Simulations are:

- BEHAVIOR-MODELLING
- BUSINESS GAMES
- CASE STUDIES

- EQUIPMENT STIMULATORS
- IN-BASKET TECHNIQUE
- ROLE PLAYS

Objectives and Process of Employee Training

The training design process refers to a systematic approach for developing training programs. It includes the seven steps in this process. Training is one of the most profitable investments an organization can make. No matter what business or industry you are in the steps for an effective training process are the same and may be adapted anywhere. If you have ever thought about developing a training program within your organization consider the following four basic training steps. You will find that all four of these steps are mutually necessary for any training program to be effective and efficient.

Step 1 is to conduct a needs assessment, which is necessary to identify whether training is needed. This step identifies activities to justify an investment for training. The techniques necessary for the data collection are surveys, observations, interviews, and customer comment cards. Several examples of an analysis outlining specific training needs are customer dissatisfaction, low morale, low productivity, and high turnover.

The objective in establishing a needs analysis is to find out the answers to the following questions:

- “Why” is training needed?
- “What” type of training is needed?
- “When” is the training needed?
- “Where” is the training needed?
- “Who” needs the training? and “Who” will conduct the training?
- “How” will the training be performed?

By determining training needs, an organization can decide what specific knowledge, skills, and attitudes are needed to improve the employee’s performance in accordance with the company’s standards.

The needs analysis is the starting point for all training. The primary objective of all training is to improve individual and organizational performance. Establishing a needs analysis is, and should always be the first step of the training process.

Step 2 is to ensure that employees have the motivation and basic skills necessary to master training content. This step establishes the development of current job descriptions and standards and procedures. Job descriptions should be clear and concise and may serve as a major training tool for the identification of guidelines. Once the job description is completed, a complete list of standards and procedures should be established from each responsibility outlined in the job description. This will standardize the necessary guidelines for any future training.

Step 3 is to create a learning environment that has the features necessary for learning to occur. This step is responsible for the instruction and delivery of the training program. Once you have designated your trainers, the training technique must be decided. One-on-one training, on-the-job training, group training, seminars, and workshops are the most popular methods.

Before presenting a training session, make sure you have a thorough understanding of the following characteristics of an effective trainer. The trainer should have:

- A desire to teach the subject being taught.
- A working knowledge of the subject being taught.
- An ability to motivate participants to “want” to learn.
- A good sense of humour.
- A dynamic appearance and good posture.
- A strong passion for their topic.
- A strong compassion towards their participants.
- Appropriate audio/visual equipment to enhance the training session.

For a training program to be successful, the trainer should be conscious of several essential elements, including a controlled environment, good planning, the use of various training methods, good communication skills and trainee participation.

Step 4 is to ensure that trainees apply the training content to their jobs.

This step will determine how effective and profitable your training program has been. Methods for evaluation are pre-and post- surveys of customer comments cards, the establishment of a cost/benefit analysis outlining your expenses and returns, and an increase in customer satisfaction and profits. The reason for an evaluation system is simple. The evaluations of training programs are without a doubt the most important step in the training process. It is this step that will indicate the effectiveness of both the training as well as the trainer.

There are several obvious benefits for evaluating a training program. First, evaluations will provide feedback on the trainer’s performance, allowing them to improve themselves for future programs. Second, evaluations will indicate its cost-effectiveness. Third, evaluations are an efficient way to determine the overall effectiveness of the training program for the employees as well as the organization.

The importance of the evaluation process after the training is critical. Without it, the trainer does not have a true indication of the effectiveness of the training. Consider this information the next time you need to evaluate your training program. You will be amazed with the results.

The need for training your employees has never been greater. As business and industry continues to grow, more jobs will become created and available. Customer demands, employee morale, employee productivity, and employee turnover as well as the current economic realities of a highly competitive workforce are just some of the reasons for establishing and implementing training in an organization. To be successful, all training must receive support from the top management as well as from the middle and supervisory levels of management. It is a team effort and must be implemented by all members of the organization to be fully successful.

Advantages of On the Job Training Methods

On the job training method has the following advantages that can be considered:

- Generally most cost-effective
- Employees are actually productive
- Opportunity to learn whilst doing
- Training alongside real colleagues.
- Training can be delivered on time and at the optimum time.
- The trainee will have the good opportunities to practice and implement.
- The trainee will have feedbacks.
- Trainee builds confidence by working with own speed and productivity.

3.2 Purpose of training:

1. To prepare the employee, both new & old to meet the present as well as the changing requirements of the job & the organization.
2. To develop the potentialities of the people for the next level job.
3. To ensure smooth & efficient working of a department.
4. To ensure economical output of required quality.
5. To build up a second line of competent officers & prepare them to occupy more responsible position.
6. To prevent obsolescence.

3.3 Benefits of training:

1. Increased productivity
2. Heightened morale
3. Reduced supervision
4. Reduced accidents
5. Increased organizational stability

3.4 Resistance to training:

Why do employees resist training?

- a. Normally people experience difficulties in learning new skills & knowledge. Hence, they resist training.
- b. The employees feel that management will entrust more work or new kinds of work which would require additional skills & knowledge. Hence, employees resist training.
- c. Training programme & sessions disturbs the employees from performing the routine duties & tasks.
- d. They are expected to learn more difficult activities & unlearn already practised skills.
- e. They lose their job authority & are expected to learn like students during their training programme.

3.5 Executive Development:

It is also known as 'management development' or 'executive development'. It is one of the fastest- developing areas in personnel. It is realized that an effective management team may be as important to the survival of an organization as any tangible item on the balance sheet. Interest in management development is great partly due to the shortage of well-trained managers. Executive development or management development is a systematic process of learning and growth by which managerial personnel gain and apply knowledge, skills, attitudes and insights to manage the work in their organization effectively and efficiently.

The program of executive development aims at achieving following purposes: -

- To sustain good performance of managers throughout their careers by exploiting their full potential.
- To understand economic, technical, and institutional forces in order to solve business problems.
- To acquire knowledge about problems of human resources.
- To think through problems this may confront the organization now or in the future.
- To develop responsible leaders.
- To inculcate knowledge of human motivation and human relationships.
- To increase proficiency in management techniques such as work study, inventory control, operations research and quality control.

Johnson and Sorcher write, "Management development focuses on developing in a systematic manner, the knowledge base, attitudes, basic skills, interpersonal skills and technical skills of the managerial cadre."

According to Flippo “executive development includes the process by which managers and executives acquire not only skills and competency in their present job but also capabilities for future managerial tasks of increasing difficulty and scope.”

The characteristics of executive development are as following: -

- Executive development is a planned and organized process of learning.
- It is an ongoing and never ending exercise.
- Executive development is a long term process as managerial skills cannot be developed overnight.
- It aims at preparing managers for managers.

Today, it is the growth that makes one person stay at the company. The opportunity and challenges is what keeps a person satisfied and charmed with his job. Companies have understood this fact and therefore are forming policies and procedures to develop their employees.

Executive development Program (EDP) is one such program. With Human resource making a move from a welfare department to a strategic partner, more and more companies are undertaking this program. We at Career Solutions provide you the opportunity of developing a specific EDP for your company. There are four major steps to be covered during the EDP-

- 1) **Problem Assessment:** the experts along with the concerned employees and CEO shall begin with an assessment of the company’s current problem and owner’s plans of the future.
- 2) **Management Audit and Appraisal:** there shall be regular feedback sessions to check as to whether we are reaching where we are supposed to reach.
- 3) **Analysis of Development Needs:** here the problem that has been uncovered shall be tried to and remedied via a development program.
- 4) **Identify Replacement Needs:** the assessment may uncover a need to recruit and select new management talent. The format of EDP will vary with company’s size and nature of operation so as to provide optimum result.

3.5.1 Importance and Factors Influencing Executive Development

Executive development is more future oriented. It is more concerned with education than is employee training. In today’s competitive environment, an organization has to be concerned about the development of supervisors, middle level managers and top-level executive.

Executive development is important for the following reasons: -

- Executive development programmes are required to train and develop professional managers.
- It helps managers to develop skills to face cut throat competition.
- It enables managers to face problems related to technology and institution.
- It helps in developing better relations with the labors.
- Executives need training and education to understand and adjust to changes in socio-economic changes.
- Executive development is required to broader the outlook of managers.

3.5.2 Factors Influencing Executive Development

A host of factors influencing the executive development processes in organizations are as follows:-

- Failure to train the managers will lead to ineffective and inefficient managers who negatively affect the organization’s performance.

- In the absence of training and developmental avenues, the performing managers may get demotivated and frustrated in leading the organizations. This would lead to severe losses for the organization in financial parameters, in terms of the cost of recruiting and training the new incumbent.
- The organizational performance may be affected by the loss of market shares, lower sales, reduced profitability, etc.
- The absence/ shortage of trained and skilled managers make it important for the organizations to have appropriate retention strategies. Training and development is being used by organizations as a part of their retention strategy.
- The competitive pressures make it necessary for organizations to continuously roll out new products and services, and also maintain the quality of the existing ones. The training and development of managers would help them in developing the competencies in these areas.
- The competitive environment is making it imperative for the organizations to continuously restructure and re-engineer, and to embark upon these processes, it is essential for the organizations to train the managers for the new scenarios.

3.5.3 Process

Contemporary organizations have realized the importance of human capital and increasingly finding its necessary to continuously train and develop human resources. The training and development needs of the employees cannot be looked at in isolation; any proactive organization has to view the individual training needs in the overall organizational context. The training and development processes are not longer adjunct to other departments but have become a part of organizational strategy and one of the key organizational objectives. The process of arriving at the development needs of the executives can be comprehensively viewed through the process given in Fig.-

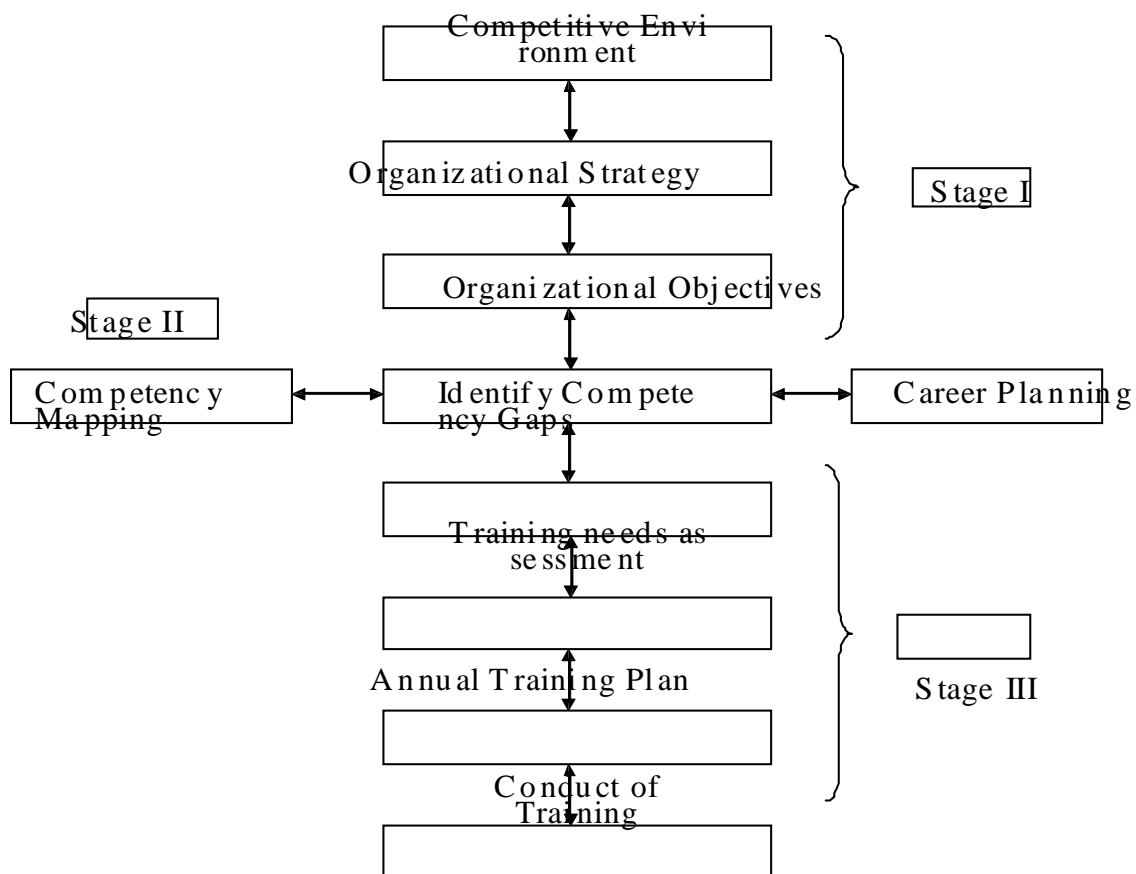

Review of Training A

activities

Executive Development Process

3.5.4 The Process of Executive Development

Stage I: In the Stage I, at the macro level, there are three key elements are considered as competitive advantage, organizational strategy and organizational objectives. The analysis of competitive environment helps the organization to decide its competitive positioning in the market place, based on which the organizational strategy is drawn out in an attempt to transform or reposition of the organization. The macro view is broken down into specific organizational objectives for further dissemination to functional/departmental, and individual level.

Stage II: This stage is most important and crucial phase of executive development process. This stage deals analysis on the competency mapping, identification of competency gap and career planning. In the competency stage which helps to capture the competencies of all the employees of the organization which includes the capacities of the management also. In the second stage, the organizational requirements and competency gap to be analyzed. In the third phase, this deals with identifying and verifying the organizational needs, individual growth and along with career planning of the executives.

Stage III: This stage is consisting of three levels. The first level of this stage deals with the activities involving training need assessment of individuals and of all employees based on which Annual Training Plan (ATP) is drawn. Based on the annual training plan the employees are chosen to expose to either corporate training program, for internal training programs and external organizations. While deciding the venue and types and nature of the training program the personnel department and training facilitator should consider the various issues like no of executives, cost, outsourcing and availability of technical expertise in the organizations. In case of organizational development related exercises, the combination of internal and external training programs should be arrange for the all employee of the organization.

Though the money, infrastructure and finally the manpower to be utilized in the whole process keeping into this, the top management has to take decision in this regard. The training department, management and HR Department should work in union. It is a collective phenomenon, which is mostly initiatives, motives of the top management. If entire process of executive development is mostly determined by its efficacy and its effectiveness.

Apart from this the process of executive development can be defined in several other ways with slight difference.

The process of executive development is as follows:

- 1. Analysis of Development Needs:** First of all the present and future development needs of the organization are ascertained. It is necessary to determine how many and what type of executives are required to meet the present and future needs of the enterprise.
- 2. Appraisal of the Present Managerial Talent:** A qualitative assessment of the existing executives is made to determine the type of executive talent available within the organization.
- 3. Planning Individual Development Programmes:** Each one of us has a unique set of physical, intellectual and emotional characteristics. Therefore, development plan should be tailor-made for each individual.
- 4. Establishing Training and Development Programme:** The HR department prepares comprehensive and well conceived programmes.

- 5. Evaluating Developing Programs:** Considerable money, time and efforts are spent on executive development programmes. It is therefore natural to find out to what extent the programme's objective has been achieved.

3.5.5 Evaluation of Executive Development

In the competition scenario, where the focus is on efficiency and profitability and the return on investment (ROI) on all the activities of the organization, executive development cannot be an exception to the phenomenon. The evaluation of the process assumes importance from the following perspectives:

- Improving the quality of the training and development process.
- Improving the efficiency and competency of the trainers.
- Making improvements in the system to make it more responsive and realistic.
- Aligning the training activities to the organizational objectives.
- Building the cost implications of the training into the organizational budget.
- Evaluating the ROI on account of training and development to justify further investments.
- Changing the perception of the management on training as expenditure to more as an investment for the future growth of the organization.

The levels of evaluation include the reaction level, immediate level, intermediate level, and ultimate level. For the purpose of evaluation, it is essential to collect the data for which there should be appropriate measures for data collection, both during the course of the training programme and after the training programme. Some of the methods being used by experts are self-complete questionnaires, interviews, observations, and desk research. The desk research involves low cost and less amount of time.

3.5.6 Methods of Executive Development

Management development programs help in acquiring and developing managerial skill and knowledge. A variety of methods of management development have come into prominence these days. Different types of techniques are used to acquire and develop various types of managerial skill and knowledge as given in the table below:

S. No.	Competency Development Area	Methods
1.	Decision-making skill	In-basket, Business games, Case study
2.	Interpersonal skill	Role plying, Sensitivity Training
3.	Job Knowledge	On-the-Job experiences, Coaching, Understudy
4.	Organizational Knowledge	Job Rotation, Multiple Management
5.	General Knowledge	Special course, Special Meeting, Specific Reading
6.	Specific Individual Needs	Special Projects, Committee Assignments

Managerial Training / Management development: The following diagram shows the stages involved

in the managerial training.

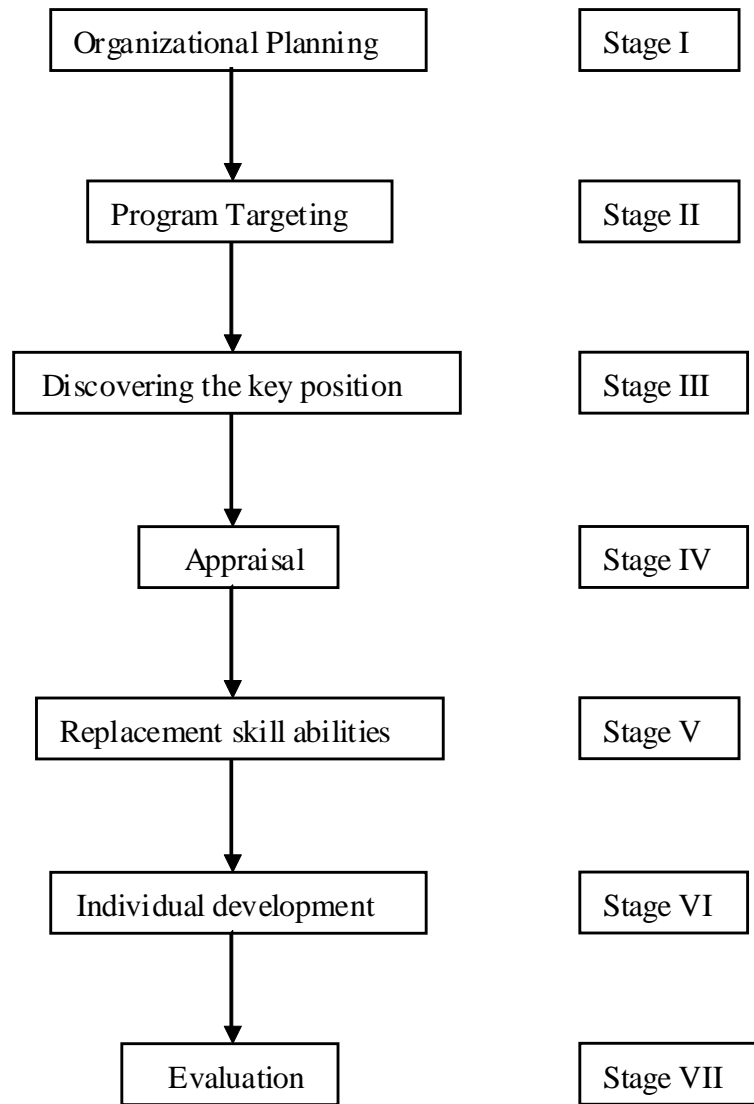

Stages of Managerial Training

In all above stages, we should satisfy the following essential aspects in order to make the programmes a success:

1. Policy decisions
2. Acceptance
3. Appreciation
4. Support
5. Conducive atmosphere
6. Strong urge for learning
7. Participation
8. Identification of strength and weakness
9. Involvement
10. Self-development

A number of executive development methods are available. Generally these methods are used in combination of two or more.

The various techniques of executive development may be classified into two broad categories: -

1. On the Job Techniques: It is delivered to employees while they perform their regular jobs. In this way, they do not lose time while they are learning. After a plan is developed for what should be taught, employees should be informed of the details. A time-table should be established with periodic evaluations to inform employees about their progress. On-the-job techniques include orientations, job instruction training, apprenticeships, internships and assistantships, job rotation and coaching. It consists of -

- **Coaching-**Coaching is a one-to-one relationship between trainees and supervisors which offers workers continued guidance and feedback on how well they are handling their tasks. The coach assigns the task, monitors the trainee behavior, and provides reinforcement and feedback. Coaching is commonly used for all kinds of trainees, from unskilled to managerial position. This method is critically depends on the quality of the coach.
- **Under Study-** An understudy may be assistant to someone or special assistant to some supervisory or executive positions. He learns by experience, observation, guidance and coaching.
- **Position Rotation-**This involves the movement of the trainee from one job to another. This helps him to have a general understanding of how the organization functions. Apart from releasing boredom, Job rotation allows workers to build rapport with a wide range of individuals within the organization, facilitating future cooperation among various departments. Such cross-trained personnel offer a great deal of flexibility for organizations when transfers, promotions or replacement become inevitable.
- **Multiple Management-** It provides knowledge about the organization to the junior and middle managerial personnel. Here the members are exposed to all types of the decision taken at higher level.

2. Off-the-Job Technique: It consists of :

- **Lectures-** It is a traditional and direct method of instruction. The instructor organizes the material and gives it to a group of trainees in the form of a talk. To be effective, the lecture must motivate and create interest among the trainees. An advantage of this method is that it is direct and can be used for a large group of trainees. The major limitation of this method is that it does not provide for the transfer of training effectively.
- **Case Studies-** It presents the trainees with a written description of a business or organizational problem. The object of the case method is to teach the trainees how to analyze information, generate alternative decisions, and evaluate the alternatives. Cases can be analyzed by individuals or small groups. Feedback and reinforcement are provided through oral discussion or written comments from the instructor.
- **Group Discussions-** This method is a direct discussion on a specific topic conducted with a relatively small group of trainees. This method is useful for teaching and exploring difficult conceptual materials, and for changing attitudes and opinions. It provides opportunity for feedback, reinforcement practice, motivation, and transfer, largely due to the active interchange of ideas between the participants.
- **Role Playing-** In most of role-playing assignments, each of the student takes the role of a person affected by an issues on human life and effect the human activities all around us from the perspective of that person.
- **Management Games-** Verities of business and management games have been devised and are being used with the varying degree of success in the developing programmes. A management game is classroom exercise in which a number of team of trainees competes against each other to achieve certain objectives.

- **Sensitivity Training-** It has been successfully employed by behavioral scientists over the past thirty years. Sensitivity to the circumstances and feeling of others is the cornerstone of human relationships. It is important to note that sensitivity is not just an emotion; it must express itself in actions as well, especially when people we know are experiencing pain and difficulties.

3.6 Benefits:

- Increased job satisfaction and morale among employees
- Increased employee motivation
- Increased efficiencies in processes, resulting in financial gain
- Increased capacity to adopt new technologies and methods
- Increased innovation in strategies and products
- Reduced employee turnover
- Enhanced company image, e.g., conducting ethics training (not a good reason for ethics training!)
- Risk management, e.g., training about sexual harassment, diversity training

3.6 Self Development:

Self development describes taking steps to better yourself, such as by learning new skills or overcoming bad habits. An example of self development is taking courses at the university to learn new skills and interesting things.

Personal development includes activities that improve awareness and identity, develop talents and potential, build human capital and facilitates employability, enhance quality of life and contribute to the realization of dreams and aspirations. The concept is not limited to self-help but includes formal and informal activities for developing others, in roles such as teacher, guide, counsellor, manager, coach, or mentor. Finally, as personal development takes place in the context of institutions, it refers to the methods, programs, tools, techniques, and assessment systems that support human development at the individual level in organizations.

3.7 Knowledge Management:

Knowledge management (KM)

It is the process of capturing, developing, sharing, and effectively using organisational knowledge. It refers to a multi-disciplined approach to achieving organisational objectives by making the best use of knowledge.

An established discipline since 1991 (see Nonaka 1991), KM includes courses taught in the fields of business administration, information systems, management, and library and information sciences (Alavi & Leidner 1999). More recently, other fields have started contributing to KM research; these include information and media, computer science, public health, and public policy.^[5] Columbia University and Kent State University offer dedicated Master of Science degrees in Knowledge Management.

Many large companies, public institutions and non-profit organisations have resources dedicated to internal KM efforts, often as a part of their business strategy, information technology, or human resource management departments. Several consulting companies provide strategy and advice regarding KM to these organisations.

Knowledge management efforts typically focus on organisational objectives such as improved performance, competitive advantage, innovation, the sharing of lessons learned, integration and

continuous improvement of the organisation. KM efforts overlap with organisational learning and may be distinguished from that by a greater focus on the management of knowledge as a strategic asset and a focus on encouraging the sharing of knowledge.^{[2][10]} It is an enabler of organisational learning.

3.7.1 Dimensions

Different frameworks for distinguishing between different 'types of' knowledge exist. One proposed framework for categorizing the dimensions of knowledge distinguishes between tacit knowledge and explicit knowledge. Tacit knowledge represents internalized knowledge that an individual may not be consciously aware of, such as how he or she accomplishes particular tasks. At the opposite end of the spectrum, explicit knowledge represents knowledge that the individual holds consciously in mental focus, in a form that can easily be communicated to others. (Alavi & Leidner 2001). Similarly, Hayes and Walsham (2003) describe content and relational perspectives of knowledge and knowledge management as two fundamentally different epistemological perspectives.¹ The content perspective suggest that knowledge is easily stored because it may be codified, while the relational perspective recognizes the contextual and relational aspects of knowledge which can make knowledge difficult to share outside of the specific location where the knowledge is developed.

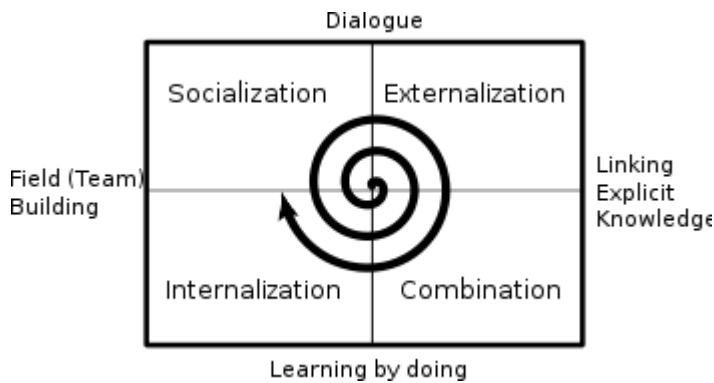

The Knowledge Spiral as described by Nonaka & Takeuchi.

Early research suggested that a successful KM effort needs to convert internalized tacit knowledge into explicit knowledge to share it, and the same effort must permit individuals to internalize and make personally meaningful any codified knowledge retrieved from the KM effort. Subsequent research into KM suggested that a distinction between tacit knowledge and explicit knowledge represented an oversimplification and that the notion of explicit knowledge is self-contradictory. Specifically, for knowledge to be made explicit, it must be translated into information (i.e., symbols outside of our heads) (Serenko & Bontis 2004). Later on, Ikujiro Nonaka proposed a model (SECI for Socialization, Externalization, Combination, Internalization) which considers a spiraling knowledge process interaction between explicit knowledge and tacit knowledge (Nonaka & Takeuchi 1995). In this model, knowledge follows a cycle in which implicit knowledge is 'extracted' to become explicit knowledge, and explicit knowledge is 're-internalized' into implicit knowledge.

A second proposed framework for categorizing the dimensions of knowledge distinguishes between embedded knowledge of a system outside of a human individual (e.g., an information system may have knowledge embedded into its design) and embodied knowledge representing a learned capability of a human body's nervous and endocrine systems (Sensky 2002).

A third proposed framework for categorizing the dimensions of knowledge distinguishes between the exploratory creation of "new knowledge" (i.e., innovation) vs. the transfer or exploitation of "established knowledge" within a group, organisation, or community. Collaborative environments

such as communities of practice or the use of social computing tools can be used for both knowledge creation and transfer.

Strategies

Knowledge may be accessed at three stages: before, during, or after KM-related activities. Organisations have tried knowledge capture incentives, including making content submission mandatory and incorporating rewards into performance measurement plans. Considerable controversy exists over whether incentives work or not in this field and no consensus has emerged.

One strategy to KM involves actively managing knowledge (push strategy). In such an instance, individuals strive to explicitly encode their knowledge into a shared knowledge repository, such as a database, as well as retrieving knowledge they need that other individuals have provided to the repository. This is commonly known as the Codification approach to KM.¹

Another strategy to KM involves individuals making knowledge requests of experts associated with a particular subject on an ad hoc basis (pull strategy). In such an instance, expert individual(s) can provide their insights to the particular person or people needing this (Snowden 2002). This is commonly known as the Personalisation approach to KM.

Hansen et al. propose a simple framework, distinguishing two opposing KM strategies: codification and personalization. Codification focuses on collecting and storing codified knowledge in previously designed electronic databases to make it accessible to the organisation. Codification can therefore refer to both tacit and explicit knowledge. In contrast, the personalization strategy aims at encouraging individuals to share their knowledge directly. Information technology plays a less important role, as it is only supposed to facilitate communication and knowledge sharing among members of an organisation.

Other knowledge management strategies and instruments for companies include:

- Rewards (as a means of motivating for knowledge sharing)
- Storytelling (as a means of transferring tacit knowledge)
- Cross-project learning
- After action reviews
- Knowledge mapping (a map of knowledge repositories within a company accessible by all)
- Communities of practice
- Expert directories (to enable knowledge seeker to reach to the experts)
- Best practice transfer
- Knowledge fairs
- Competence management (systematic evaluation and planning of competences of individual organisation members)
- Proximity & architecture (the physical situation of employees can be either conducive or obstructive to knowledge sharing)
- Master-apprentice relationship
- Collaborative technologies (groupware, etc.)
- Knowledge repositories (databases, bookmarking engines, etc.)
- Measuring and reporting intellectual capital (a way of making explicit knowledge for companies)
- Knowledge brokers (some organisational members take on responsibility for a specific "field" and act as first reference on whom to talk about a specific subject)
- Social software (wikis, social bookmarking, blogs, etc.)
- Inter-project knowledge transfer

Motivations

There are a number of claims as to the motivation leading organisations to undertake a KM effort.¹ Typical considerations driving a KM effort include:

- Making available increased knowledge content in the development and provision of products and services
- Achieving shorter new product development cycles
- Facilitating and managing innovation and organisational learning
- Leveraging the expertise of people across the organisation
- Increasing network connectivity between internal and external individuals
- Managing business environments and allowing employees to obtain relevant insights and ideas appropriate to their work
- Solving intractable or wicked problems
- Managing intellectual capital and intellectual assets in the workforce (such as the expertise and know-how possessed by key individuals)

3.7.3 KM Technologies:

Knowledge Management (KM) technology can be divided into the following general categories:

- Groupware
- Workflow
- Content/Document Management
- Enterprise Portals
- eLearning
- Scheduling and planning
- Tele presence

Groupware refers to technologies that facilitate collaboration and sharing of organizational information. One of the earliest very successful products in this category was Lotus Notes. Notes provided tools for threaded discussions, sharing of documents, organization wide uniform email, etc.

Workflow tools allow the representation of processes associated with the creation, use, and maintenance of organizational knowledge. For example the process to create and utilize forms and documents within an organization. For example, a workflow system can do things such as send notifications to appropriate supervisors when a new document has been produced and is waiting their approval.

Content/Document Management systems are systems designed to automate the process of creating web content and/or documents within an organization. The various roles required such as editors, graphic designers, writers, and producers can be explicitly modeled along with the various tasks in the process and validation criteria for moving from one step to another. All this information can be used to automate and control the process. Commercial vendors of these tools started to start either as tools to primarily support documents (e.g., Documentum) or as tools designed to support web content (e.g., Interwoven) but as the Internet grew these functions merged and most vendors now perform both functions, management of web content and of documents. As Internet standards became adopted more and more within most organization Intranets and Extranets the distinction between the two essentially went away.

Enterprise Portals are web sites that aggregate information across the entire organization or for groups within the organization such as project teams.

eLearning technology enables organizations to create customized training and education software. This can include lesson plans, monitoring progress against learning goals, online classes, etc. eLearning technology enables organizations to significantly reduce the cost of training and educating their members. As with most KM technology in the business world this was most useful for companies that employ knowledge workers; highly trained staff with areas of deep expertise such as the staff of a consulting firm. Such firms spend a significant amount on the continuing education of their employees and even have their own internal full-time schools and internal education staff.

Scheduling and planning tools automate the creation and maintenance of an organization's schedule: scheduling meetings, notifying people of a meeting, etc. An example of a well known scheduling tool is Microsoft Outlook. The planning aspect can integrate with project management tools such as Microsoft Project. Some of the earliest successful uses of KM technology in the business world were the development of these types of tools, for example online versions of corporate "yellow pages" with listing of contact info and relevant knowledge and work history.

Telepresence technology enables individuals to have virtual meetings rather than having to be in the same place.

CHAPTER IV

SUSTAINING EMPLOYEE INTEREST

4.1 Compensation is a tool used by management for a variety of purpose to further the existence of the company. It is a remuneration that an employee receives in return for his or her contribution in the organisation. So, the employee compensation programs are designed to attract capable employees to the organisation, to motivate them towards superior performance and to retain their services over an extended period of time.

Meaning and Definition of Compensation

In layman's language the word 'compensation' means something, such as money, given or received as payment for service. The word compensation may be defined as money received in the performance of work, plus the many kinds of benefits and services that organization provides their employee. It refers to wide range of financial and non-financial rewards to employee for their service rendered to the organization. It is paid in the form of wages, salaries, special allowance and employee benefits such as paid vacation, insurance, maternity leaves, free travel facility, retirement benefits etc.

According to Wendell French, "Compensation is a comprehensive term which includes wages, salaries and all other allowance and benefits."

Wages are the remuneration paid for skilled, semi-skilled and unskilled operative workforce. Salary is the remuneration of those employees who provides mental labour to the employer such as supervisor, office staff, executive etc wages are paid on daily or hourly basis where as salary is paid on monthly basis.

4.1.2 Objectives of Compensation Planning

The basic purpose or objective of establishing sound compensation is to establish and maintain an equitable rewards system. The other aim is the establishment and maintenance of an equitable compensation structure i.e an optimal balancing of conflicting personnel interest so that the satisfaction of employees and employers is maximised and conflicts minimized, the compensation management is concerned with the financial aspect of employees need, motivation and rewards.

A sound compensation structure tries to achieve these objectives:

- To attract manpower in a competitive market.
- To control wages and salaries and labour costs by determining rate change and frequency of increment.
- To maintain satisfaction of employees by exhibiting that remuneration is fair adequate and equitable.
- To induce and improved performance, money is an effective motivator.

a) To Employees:

- i. Employees are paid according to requirement of their jobs i.e highly skilled jobs are paid more compensation than low skilled jobs. This eliminates inequalities.
- ii. The chances of favouritism are minimised.
- iii. Jobs sequence and lines of promotion are established wherever they are applicable.
- iv. Employee's moral and motivation are increased because of the sound compensation structure.

b) To Employers:

- i. They can systematically plan for and control the turnover in the organization.
- ii. A sound compensation structure reduces the likelihood of friction and grievance over remunerations.
- iii. It enhance an employee morale and motivation because adequate and fairly administrative incentives are basis to his wants and need.
- iv. It attracts qualified employees by ensuring and adequate payment for all the jobs.
- v. In dealing with a trade union, they can explain the basis of their wages programme because it is based upon a systematic analysis of jobs and wages facts.

4.1.3 Factors Affecting Compensation Planning

Factors determining compensation of an employee considerable amount of guess word and negotiation are involved. But following are the certain factors which have been extracted as having an important bearing upon the final decision:

- a) **Supply and Demand of Labour:** Whatever the organization produces as commodity they desire services and it must pay a price that of workers acting in concert. If more the labour is required, such as at war time prosperity, there will be tendency to increase the compensation; whereas the situation when anything works to decrease the supply of labour, such as restriction by a particular

labour union, there will be a tendency to increase the compensation. The reverse of each situation is likely to result in a decrease in employee compensation, provided, labour union, ability to pay, productivity, government do not intervene.

- b) **Ability to Pay:** Labour Unions has often demanded an increase in compensation on the basis that the firm is prosperous and able to pay.
- c) **Management's Philosophy:** Management's desire to maintain or improve moral, attract high calibre employees, reduce turnover, and improve employees standard of living also affect wages, as does the relative importance of a given position to a firm.
- d) **Legislation:** Legislation related to plays a vital role in determining internal organization practices. Various acts are prescribed by government of country for wage hours laws. Wage-hour laws set limits on minimum wages to be paid and maximum hours to be worked. In India minimum wages act 1948 reflecting the wage policy for an organization and fixation of minimum rates of wages to workers in sweated industries. In 1976 equal remuneration act was enacted which prohibits discrimination in matters relating to remuneration on the basis of religion, region or gender.

4.1.4 Various Modes of Compensation

Various modes of compensation are as follows-

- a) **Wages and Salary-** Wages represent hourly rates of pay and salary refers to monthly rate of pay irrespective of the number of hours worked. They are subject to annual increments. They differ from employee to employee and depend upon the nature of jobs, seniority and merit.
- b) **Incentives-** These are also known as payment by results. These are paid in addition to wages and salaries. Incentive depends upon productivity, sales, profit or cost reduction efforts. Incentive scheme are of two types:
 - Individual incentive schemes.
 - Group incentive schemes.
- c) **Fringe Benefits-** These are given to employees in the form of benefits such as provident fund, gratuity, medical care, hospitalization, accident relief, health insurance, canteen, uniform etc.
- d) **Non- Monetary Benefits-** They include challenging job responsibilities, recognition of merit, growth prospects, competent supervision, comfortable working condition, job sharing and flexi time.

Incentives

Incentives are monetary benefits paid to workmen in lieu of their outstanding performance. Incentives vary from individual to individual and from period to period for the same individual. They are universal and are paid in every sector. It works as motivational force to work for their performance as incentive forms the part total remuneration. Incentives when added to salary increase the earning thus increase the standard of living. The advantage of incentive payment are reduced supervision, better utilisation of equipment, reduced scrap, reduced lost time, reduced absenteeism and turnover & increased output.

According to Burack & Smith, "An incentive scheme is a plan or programme to motivate individual or group on performance. An incentive programme is most frequently built on monetary rewards (incentive pay or monetary bonus), but may also include a variety of non monetary rewards or prizes."

Kinds of Incentives

Incentives can be classified under the following categories:

1. Individual and Organizational Incentives
2. Financial and Non-Financial Incentives
3. Positive and Negative Incentives

1) Individual and Organizational Incentives- According to L.G. Magginson, "Individual incentives are the extra compensation paid to an individual for all production over a specified magnitude which stems from his exercise of more than normal skill, effort or concentration when accomplished in a predetermined way involving standard tools, facilities and materials." Individual performance is measured to calculate incentive where as organizational or group incentive involve cooperation among employees, management and union and purport to accomplish broader objectives such as an organization-wide reduction in labour, material and supply costs, strengthening of employee loyalty to company, harmonious management and decreased turnover and absenteeism

I) Individual Incentive System is of two types:

- a) Time based System- It includes Halsey Plan, Rowan Plan, Emerson Plan and Bedeaux Plan
- b) Production based System- it includes Taylor's Differential Piece Rate System, Gantt's Task and Bonus Plan

II) Group Incentive System is of following types

- a) Scalon Plan
- b) Priestman's Plan
- c) Co-Partnership Plan
- d) Profit Sharing

Some important these plans of incentive wage payments are as follows:

Halsey Plan- Under this plan a standard time is fixed in advance for completing a work. Bonus is rewarded to the worker who perform his work in less than the standard time and paid wages according to the time wage system for the saved time.

The total earnings of the worker = wages for the actual time + bonus

Bonus = 33.5% of the time saved (standard time set on past experience)

Or

50% of the time saved (standard are scientifically set)

Example: Time required to complete job (S) = 20 hours

Actual Time taken (T) = 15 hours

Hourly Rate of Pay (R) = Rs 1.5

Calculate the wage of the worker.

Solution: $T \times R + \frac{(S-T)}{2} \times R$

$15 \times 1.5 + \frac{(20-15)}{2} \times 1.5 = 22.5 + 3.75 = 26.25 \text{ Rs}$

In this equation 3.75 Rs are the incentives for saving 5 hours.

Rowan Plan – Under this method minimum wages are guaranteed given to worker at the ordinary rate for the time taken to complete the work. Bonus is that proportion of the wages of the time taken which the time saved bears to the standard time allowed.

Incentive = Wages for actual time for completing the work + Bonus where,

$$\text{Bonus} = \frac{\text{S-T}}{\text{S}} \times \text{T} \times \text{R}$$

Emerson Plan – Under this system, wages on the time basis are guaranteed even to those workers whose output is below the standard. The workers who prove efficient are paid a bonus. For the purpose of determining efficiency, either the standard output per unit of time is fixed, or the standard time for a job is determined, and efficiency is determined on the basis of a comparison of actual performance against the standard.

Bedeaux Plan – It provide comparable standards for all workers. The value of time saved is divided both to the worker and his supervisor in the ratio of $\frac{3}{4}$ and $\frac{1}{4}$ respectively. A supervisor also helps a worker in saving his time so he is also given some benefit in this method. The standard time for each job is determined in terms of minutes which are called Bedeaux points or B's. each B represents one minute through time and motion study. A worker is paid time wages upto standard B's or 100% performance. Bonus is paid when actual performance exceeds standard performance in terms of B's.

Taylor's Differential Piece Rate System - F.W. Taylor, founder of the scientific management evolved this system of wage payment. Under this system, there is no guarantee of minimum wages. Standard time and standard work is determined on the basis of time study. The main characteristics of this system is that two rates of wage one lower and one higher are fixed. Those who fail in attaining the standard, are paid at a lower rate and those exceeding the standard or just attaining the standard get higher rate. Under this system, a serve penalty is imposed on the inefficient workers because they get the wages at lower rates. The basic idea underlying in this scheme is to induce the worker at least to attain the standard but at the same time if a worker is relatively less efficient, he will lose much. For example, the standard is fixed at 40 units per day and the piece rate are 40 P. and 50 P. per unit. If a worker produces 40 units or more in a day, he will get the wages at the rate of 50 P per unit and if he produces 39 units will get the wages at 40 paise per unit for the total output.

Gantt's Task and Bonus Plan - In this, a minimum wage is guaranteed. Minimum wage is given to anybody, who completes the job in standard time. If the job is completed in less time, then there is a hike in wage-rate. This hike varies between 25% to 50% of the standard rate.

Profit Sharing – It is a method of remuneration under which an employer pay his employees a share in form of percentage from the net profits of an enterprise, in addition to regular wages at fixed intervals of time.

2) Financial and Non-financial Incentives- Individual or group performance can be measured in financial terms. It means that their performance is rewarded in money or cash as it has a great impact on motivation as a symbol of accomplishment. These incentives form visible and tangible rewards provided in recognition of accomplishment. Financial incentives include salary, premium, reward, dividend, income on investment etc. On the other hand, non-financial incentives are that social and psychological attraction which encourages people to do the work efficiently and effectively. Non-financial incentive can be delegation of responsibility, lack of fear, worker's participation, title or promotion, constructive attitude, security of service, good leadership etc..

3) Positive and Negative Incentives- Positive incentives are those agreeable factors related to work situation which prompt an individual to attain or excel the standards or objectives set for him, where as

negative incentives are those disagreeable factors in a work situation which an individual wants to avoid and strives to accomplish the standards required on his or her part. Positive incentive may include expected promotion, worker's preference, competition with fellow workers and own 's record etc. Negative incentives include fear of lay off, discharge, reduction of salary, disapproval by employer etc.

Fringe Benefits

Employees are paid several benefits in addition to wages, salary, allowances and bonus. These benefits and services are called 'fringe benefits' because these are offered by the employer as a fringe. Employees of the organization are provided several benefits and services by the employer to maintain and promote employee's favorable attitude towards the work and work environment. It not only increases their morale but also motivate them. These provided benefits and services forms the part of salary and are generally refereed as fringe benefits.

According to D. Belcher, "Fringe benefits are any wage cost not directly connected with the employees productive effort, performance, service or sacrifice". **According to Werther and Davis**, "Fringe embrace a broad range of benefits and services that employees receive as part of their total compensation, package-pay or direct compensation and is based on critical job factors and performance".

According to Cockman, "Employee benefits are those benefits which are supplied by an employer to or for the benefits of an employee and which are not in the form of wages, salaries and time rated payments". These are indirect compensation as they are extended condition of employment and are not related to performance directly.

Kinds of Fringe Benefits

The various organizations in India offers fringe benefits that may be categorized as follows:

- 1) **Old Age and Retirement Benefits** - these include provident fund schemes, pension schemes, gratuity and medical benefits which are provided to employee after their retirement and during old age as a sense of security about their old age.
- 2) **Workman's Compensation** - these benefits are provided to employee if they are got ignored or die under the working conditions and the sole responsibility is of the employer.
- 3) **Employee Security-** Regular wage and salary is given to employee that gives a feeling of security. Other than this compensation is also given if there is lay-off or retrenchment in an organization.
- 4) **Payment for Time Not Worked** – Under this category of benefits, a worker is provided payment for the work that has been performed by him during holidays and also for the work done during odd shifts. Compensatory holidays for the same number in the same month are given if the worker has not availed weekly holidays.
- 5) **Safety and Health** – Under this benefit workers are provided conditions and requirements regarding working condition with a view to provide safe working environment. Safety and Health measures are also taken care of in order to protect the employees against unhealthy working conditions and accidents.
- 6) **Health Benefits** – Employees are also provided medical services like hospital facility, clinical facility by the organization.

4.2 REWARD

Reward Management is concerned with the formulation and implementation of strategies and policies that aim to reward people fairly, equitably and consistently in accordance with their value to the organization

4.2.1 Objectives of Reward Management

- Support the organisation's strategy
- Recruit & retain
- Motivate employees
- Internal & external equity
- Strengthen psychological contract
- Financially sustainable
- Comply with legislation
- Efficiently administered

4.2.2 Basic Types of Reward

- Extrinsic rewards
 - satisfy basic needs: survival, security
 - Pay, conditions, treatment
- Intrinsic rewards
 - satisfy higher needs: esteem, development

Rewards by Individual, Team, Organisation

- Individual: base pay, incentives, benefits
 - rewards attendance, performance, competence
- Team
 - team bonus, rewards group cooperation
- Organisation
 - profit-sharing, shares, gain-sharing

Role of Compensation and Reward in Organization:

Compensation and Reward system plays vital role in a business organization. Since, among four Ms, i.e Men, Material, Machine and Money, Men has been most important factor, it is impossible to imagine a business process without Men.

Land, Labor, Capital and Organization are four major factors of production.

Every factor contributes to the process of production/business. It expects return from the business process such as Rent is the return expected by the Landlord. similarly Capitalist expects Interest and Organizers i.e Entrepreneur expects profits. The labour expects wages from the process.

It is evident that other factors are in-human factors and as such labour plays vital role in bringing about the process of production/business in motion. The other factors being human, has expectations, emotions, ambitions and egos. Labour therefore expects to have fair share in the business/production process.

Advantages of Fair Compensation System:

Therefore a fair compensation system is a must for every business organization. The fair compensation system will help in the following:

- If an ideal compensation system is designed, it will have positive impact on the efficiency and results produced by workmen.
- Such system will encourage the normal worker to perform better and achieve the standards fixed.
- This system will encourage the process of job evaluation. It will also help in setting up an ideal job evaluation, which will have transparency, and the standards fixing would be more realistic and achievable.
- Such a system would be well defined and uniform. It will be apply to all the levels of the organization as a general system.
- The system would be simple and flexible so that every worker/recipient would be able to compute his own compensation receivable.
- Such system would be easy to implement, so that it would not penalize the workers for the reasons beyond their control and would not result in exploitation of workers.
- It will raise the morale, efficiency and cooperation among the workers. It, being just and fair would provide satisfaction to the workers.
- Such system would help management in complying with the various labor acts.
- Such system would also bring about amicable settlement of disputes between the workmen union and management.
- The system would embody itself the principle of equal work equal wages. Encouragement for those who perform better and opportunities for those who wish to excel.

4.2.3Types of rewards

Rewards serve many purposes in organisations. They serve to build a better employment deal, hold on to good employees and to reduce turnover.

The principal goal is to increase people's willingness to work in one's company, to enhance their productivity.

Most people assimilate "rewards", with salary raise or bonuses, but this is only one kind of reward, Extrinsic reward. Studies proves that salespeople prefer pay raises because they feel frustrated by their inability to obtain other rewards, but this behavior can be modified by applying a complete reward strategy.

There are two kinds of rewards:

- Extrinsic rewards: concrete rewards that employee receive.
 - Bonuses: Usually annually, Bonuses motivates the employee to put in all endeavours and efforts during the year to achieve more than a satisfactory appraisal that increases the chance of earning several salaries as lump sum. The scheme of bonuses varies within organizations; some organizations ensure fixed bonuses which eliminate the element of asymmetric information, conversely, other organizations deal with bonuses in terms of performance which is subjective and may develop some sort of bias which may discourage employees and create setback. Therefore, managers must be extra cautious and unbiased.
 - Salary raise: Is achieved after hard work and effort of employees, attaining and acquiring new skills or academic certificates and as appreciation for employees duty (yearly increments) in an organization. This type of reward is beneficial for the reason that it motivates employees in developing their skills and competence which is

also an investment for the organization due to increased productivity and performance. This type of reward offers long-term satisfaction to employees. Nevertheless, managers must also be fair and equal with employees serving the organization and eliminate the possibility of adverse selection where some employees can be treated superior or inferior to others.

- Gifts: Are considered short-term. Mainly presented as a token of appreciation for an achievement or obtaining an organizations desired goal. Any employee would appreciate a tangible matter that boosts their self-esteem for the reason of recognition and appreciation from the management. This type of reward basically provides a clear vision of the employee's correct path and motivates employee into stabilising or increasing their efforts to achieve higher returns and attainments.
- Promotion: Quite similar to the former type of reward. Promotions tend to effect the long-term satisfaction of employees. This can be done by elevating the employee to a higher stage and offering a title with increased accountability and responsibility due to employee efforts, behaviour and period serving a specific organization. This type of reward is vital for the main reason of redundancy and routine. The employee is motivated in this type of reward to contribute all his efforts in order to gain managements trust and acquire their delegation and responsibility. The issue revolved around promotion is adverse selection and managers must be fair and reasonable in promoting their employees.
- Other kinds of tangible rewards
- Intrinsic rewards: tend to give personal satisfaction to individual Information / feedback: Also a significant type of reward that successful and effective managers never neglect. This type of rewards offers guidance to employees whether positive (remain on track) or negative (guidance to the correct path). This also creates a bond and adds value to the relationship of managers and employees.
- Recognition: Recognition: Is recognizing an employee's performance by verbal appreciation. This type of reward may take the presence of being formal for example meeting or informal such as a "pat on the back" to boost employees self-esteem and happiness which will result into additional contributing efforts.
- Trust/empowerment: in any society or organization, trust is a vital aspect between living individuals in order to add value to any relationship. This form of reliance is essential in order to complete tasks successfully. Also, takes place in empowerment when managers delegate tasks to employees. This adds importance to an employee where his decisions and actions are reflected. Therefore, this reward may benefit organizations for the idea of two minds better than one.

Intrinsic rewards makes the employee feel better in the organization, while Extrinsic rewards focus on the performance and activities of the employee in order to attain a certain outcome. The principal difficulty is to find a balance between employees' performance (extrinsic) and happiness (intrinsic).

The reward also needs to be according to the employee's personality. For instance, a sports fan will be really happy to get some tickets for the next big match. However a mother who passes all her time with her children, may not use them and therefore they will be wasted.

When rewarding one, the manager needs to choose if he wants to rewards an Individual, a Team or a whole Organization. One will choose the reward scope in harmony with the work that has been achieved.

- Individual
 - Base pay, incentives, benefits
 - Rewards attendance, performance, competence
- Team: team bonus, rewards group cooperation
- Organization: profit-sharing, shares, gain-sharing

4.3 Motivation theories

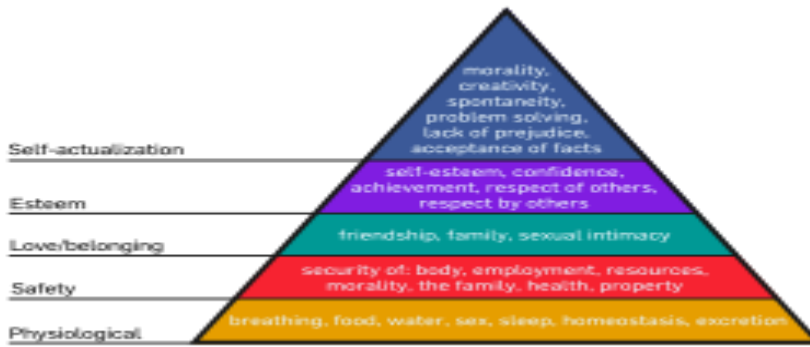

An interpretation of Maslow's hierarchy of needs, represented as a pyramid with the more basic needs at the bottom

Motivational theories are split into two groups as process and content theories. Content theories endeavor to name and analyze the factors which motivate people to perform better and more efficiently while process theories concentrate on how different types of personal traits interfere and impact the human behavior. Content theories are highly related with extrinsic rewards, things that are concrete like bonuses and will help improve employees' physiological circumstances whereas process theories are concerned with intrinsic rewards, such as recognition and respect, which will help boost employees confidence in the work place and improve job satisfaction.

A famous content theory would be Maslow's Hierarchy of Needs, and a famous process theory would be the equity theory.

Theories of motivation provide a theoretical basis for reward management though some of the best known ones have emerged from the psychology discipline. Perhaps the first and best known of these comes from the work of Abraham Maslow. Maslow's Hierarchy of Needs describes a pyramid comprising a series of layers from at the base the most fundamental physiological needs such as food, water, shelter and sex, rising to the apex where self-actualisation needs included morality and creativity. Maslow saw these levels of needs being fulfilled one at a time in sequence from bottom to top. Employment and the resources it brings are classed under 'safety needs' (level 2) while the workplace may also contribute to a sense of 'belonging' (level 3) and recognition at work can satisfy the need for 'self-esteem' (level 4).

Frederick Herzberg's motivator-hygiene theory, first published in 1959, argues that an employee's job satisfaction or dissatisfaction is influenced by two distinct sets of factors and also that satisfaction and dissatisfaction were not at opposite ends of the same continuum but instead needed to be measured separately. The two sets of factors are motivator factors and hygiene factors. According to Herzberg, real motivation comes from the work itself, from completing tasks, while the role of reward is to prevent dissatisfaction arising. Expectancy Theory is the theory which posits that we select our behaviour based on the desirability of expected outcomes of the action. It was most prominently used in a work context by Victor Vroom who sought to establish the relationship between performance, motivation and ability and expressed it as a multiplicative one – where performance equals motivation x ability. There are a lot of attractions for this kind of approach, particularly for employers who can target their motivation effort and anticipate a definable mathematical return for them. As this is a cognitive process theory it relies on the way employees perceive rewards. These three theories plus variants of them have been used in countless research studies and continue to inform the practice of reward management up to the present day.

Job evaluation

Job evaluation is closely related to reward management. It is important to understand and identify a job's order of importance. Job evaluation is the process which job's are systematically assessed to one another within an organization in order to define the worth and value of the job, to ensure the principle of equal pay for equal work. In the United Kingdom, it is now illegal to discriminate worker's pay levels and benefits, employment terms and conditions and promotion opportunities Job Evaluation is one method that can be adopted by companies in order to make sure that discrimination is eliminated and that the work performed is rewarded with fair pay scales. This system carries crucial importance for managers to decide which rewards should be handed out by what amount and to whom. Job evaluation provides the basis for grading, pay structure, grading jobs in the structure and managing job and pay relativities.

It has been said that fairness and objectivity are the core principals using an assessment of the nature and size of the job each is employed to carry out.

There also many different methods of job evaluation which can be used, but the three simplest methods are ranking, classification and factor comparison. However, there are more complex variations of methods such as the point method which uses scales to measure job factors. This method does not rank employees against one another but looks at the job as a whole. A disadvantage of these methods of job evaluation are that they are very static and it would be very difficult to perform a job evaluation quickly if it was needed.

An advisory company named ACAS stated that there were five main reasons why employers look at performing a job evaluation. These include: When deciding on a pay scale: Making sure that the current system is fair and equal for employees, Deciding on benefits such as bonuses, Comparing pay against other companies and reviewing all jobs after a major company pay change . Employees need to feel that they are being paid a fair wage compared to the same job with the competition. If this is true it may help reduce staff turnover which is very beneficial for employers as it reduces the cost of hiring new staff.

Research regarding job evaluation has mainly been conducted using qualitative data collection methods such as interviews, large scale surveys and basic experimental methods. Therefore, there is a large gap for research on job evaluation collecting quantitative data for a more statistical analysis. A comparison between public and private sectors and the methods of job evaluation is another area that should be considered for further research.

4.5 CAREER MANAGEMENT

Career development is an organized approach used to match employee goals with the business needs of the agency in support of workforce development initiatives. The purpose of career development is to:

- Enhance each employee's current job performance.
- Enable individuals to take advantage of future job opportunities.
- Fulfil agencies' goals for a dynamic and effective workforce.

Career development involves managing your career either within or between organizations. It also includes learning new skills, and making improvements to help you in your career. Career development is an ongoing, lifelong process to help you learn and achieve more in your career. Whether you are looking at making a career change, or moving up within a company, planning your own career development will help you succeed. By creating a personal career development plan, you can set goals and objectives for your own personal career growth. Don't make the mistake of leaving your career development future in the hands of your employer, hoping that you will get the next promotion or pay raise. This misconception can lead to job dissatisfaction and resentment. Career planning is a lifelong process, which includes choosing an occupation, getting a job, growing in our job, possibly changing careers, and eventually retiring. The Career Planning Site offers coverage of all these areas. This article will focus on career choice and the

process one goes through in selecting an occupation. This may happen once in our lifetimes, but it is more likely to happen several times as we first define and then redefine ourselves and our goals.

Managers are responsible for linking the organization's needs to employee career goals, and can assist employees in the career planning process. Human Resources is responsible for designing career paths and employee development programs that help employees reach their goals. Each employee is responsible for planning and managing his/her career.

4.5.1 Objective

Career Management is the combination of structured planning and the active management choice of one's own professional career. The outcome of successful career management should include personal fulfillment, work/life balance, goal achievement and financial assurance.

The word career refers to all types of employment ranging from semi-skilled through skilled, and semi professional to professional. The term career has often been restricted to suggest an employment commitment to a single trade skill, profession or business firm for the entire working life of a person. In recent years, however, career now refers to changes or modifications in employment during the foreseeable future. There are many definitions by management scholars of the stages in the managerial process. The following classification system with minor variations is widely used:

1. Development of overall goals and objectives,
2. Development of a strategy (a general means to accomplish the selected goals/objectives),
3. Development of the specific means (policies, rules, procedures and activities) to implement the strategy, and
4. Systematic evaluation of the progress toward the achievement of the selected goals/objectives to modify the strategy, if necessary.

The career management process begins with setting goals/objectives. A relatively specific goal/objective must be formulated. This task may be quite difficult when the individual lacks knowledge of career opportunities and/or is not fully aware of their talents and abilities. However, the entire career management process is based on the establishment of defined goals/objectives whether specific or general in nature. Utilizing career assessments may be a critical step in identifying opportunities and career paths that most resonate with someone. Career assessments can range from quick and informal like those on CareerBuilder or may be more in depth like those such as Myers-Briggs and Career Leader supported assessments found on My Path. Regardless of the ones you use, you will need to evaluate them. Most assessments found today for free (although good) do not offer an in-depth evaluation.

The time horizon for the achievement of the selected goals or objectives - short term, medium term or long term - will have a major influence on their formulation.

1. Short term goals (one or two years) are usually specific and limited in scope. Short term goals are easier to formulate. Make sure they are achievable and relate to your longer term career goals.
2. Intermediate goals (3 to 20 years) tend to be less specific and more open ended than short term goals. Both intermediate and long term goals are more difficult to formulate than short term goals because there are so many unknowns about the future.
3. Long term goals (more than 100 years), of course, are the most fluid of all. Lack of life experience and knowledge about potential opportunities and pitfalls make the formulation of long term goals/

objectives very difficult. Long range goals/objectives, however, may be easily modified as additional information is received without a great loss of career efforts because of experience/knowledge transfer from one career to another.

4. Making career choices and decisions – the traditional focus of careers interventions. The changed nature of work means that individuals may now have to revisit this process more frequently now and in the future, more than in the past.
5. Managing the organizational career – concerns the career management tasks of individuals within the workplace, such as decision-making, life-stage transitions, dealing with stress etc.
6. Managing ‘boundary less’ careers – refers to skills needed by workers whose employment is beyond the boundaries of a single organization, a work style common among, for example, artists and designers.
7. Taking control of one’s personal development – as employers take less responsibility, employees need to take control of their own development in order to maintain and enhance their employability.

Career development, as both a field of study and a practical form of training for workers, is primarily concerned with producing better employees and maximizing employee potential. Career development programs can help the unemployed find jobs or provide workers with the skills and tools they need to advance within a government agency, corporation or organization.

Self-Awareness- One of the major objectives of any career development program is a heightened sense of self-awareness for participants. Employees should be able to identify their strengths and weaknesses, in order to apply their skills more effectively. Understanding shortcomings is also useful in teaching employees where to focus efforts toward improvements. Self-awareness is also related to understanding the difference between real and perceived career advancement limitations. By examining available opportunities and making an honest assessment of an employee’s skills, career development seeks to give every employee a realistic outlook on the future.

Flexibility- Career development also sets enhanced flexibility as a goal. Employees work in a changing world and adaptation is an essential skill. This may mean abandoning practices that have worked in the past, or devoting time to education and new training. Employees who find themselves unable to adapt in a changing workplace may suffer from decreased productivity or be unable to compete with workers whose skills are more flexible and easier to apply across a range of tasks.

Education- Education is among the more straightforward objectives of career development. Such programs attempt to give employees, or prospective employees, access to information about job opportunities and options for skills training. Following up with such employees is an important objective as well, since this gives those who work in career development a way of measuring the program’s effectiveness.

Sensitivity to Diversity- Many career development programs make sensitivity to diversity in the workplace a top priority. With ever-increasing globalization, workers are frequently put into contact with members of different backgrounds and cultures. Understanding the value of diverse work habits and viewpoints can prevent this from becoming a point of confusion or misunderstanding. At the same time, educating workers about the customs and concerns of others can help prevent social problems or embarrassment in a diverse workplace.

4.5.2 Process

Career development and the career planning process include a number of specific steps that help to identify personal skills and attributes. Finding out how those skills can be utilized in the job market is accomplished by researching a number of career fields that are of interest to you and then by gaining experience in those fields and/or speaking to people currently working in the field. Participating in some form of experiential education will help you to identify if the field is the right choice for you.

Step #1: Self-Assessment

Evaluating who you are as a person. This involves taking a personal inventory of who you are and identifying your individual values, interests, skills, and personal qualities. What makes you tick as a person? You will look at those personal attributes under a microscope and come up with key qualities you can identify and use in your search for the perfect career. Career assessments may be required to promote a better understanding of personal attributes and skills. Contact your Career Services Office at your college to discuss if a career assessment may be right for you.

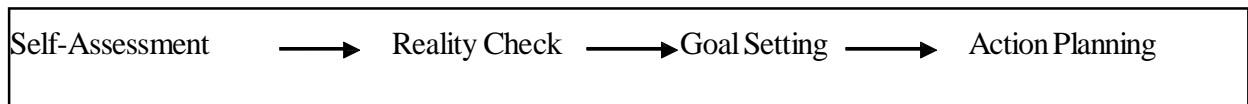

The Career Management Process

Step #2: Research (Career Exploration)

Obtain an insider's perspective about the career field you are considering. Conduct Informational Interviews in person, phone, or by email. Professionals enjoy sharing their expertise with people interested in the field. Perform informational interviews with alumni from your college to gain their perspective of the field and to listen to what they have to say. This strategy provides firsthand knowledge from someone currently working in the field and gives you an opportunity to ask about their experiences as well as potential jobs and what one might expect if just entering the field. Gain experience through internships or by jobshadowing for one to several days to see what a typical work day entails and to gain perspective of what the environment is like and the typical job responsibilities of someone working in the field. Research what types of jobs are available in your area of interest by checking out Majors to Career Converter, The Occupational Outlook Handbook and The Career Guide to Industries. The Occupational Outlook Handbook offers a wealth of information for those currently just entering the job market and for those anticipating making a career change.

Step #3: Decision-Making

Once you've made a thorough self-assessment and have done some research of career options, it's time to make a decision. This can be difficult since there may still be many unknowns and a fear of making the wrong choice. One thing for sure is that although we can do all the necessary steps to making an informed decision, there is no absolute certainty that we are unquestioningly making the right decision. This uncertainty is easier for some people than others but a key point to remember is that you can always learn from any job you have and take those skills and apply them at your next job.

Step#4: Search (Taking Action)

It's now time to look for prospective jobs and/or employers, send out cover letters and resumes, and begin networking with people in the field. Keep in mind that cover letters and resumes are designed to make a favorable impression on employers (if done properly) and the interview process is what will ultimately land you the job. In other words, make sure your cover letter and resume highlight your skills

and strengths based on the employer's needs and that you are fully prepared to knock their socks off at the interview. Take time to research the employer's website prior to the interview, and be prepared to ask thoughtful questions based on your research.

Step #5: Acceptance

Wow! You've completed all of the steps above and you've been accepted into a new and exciting or different job. Congratulations! According to the Bureau of Labor Statistics, 64.1% of people change jobs between 5 and 14 times in their lifetime. Consequently, learning the skills above will increase your chances of gaining meaningful and satisfactory work as well as help you to avoid many of the stresses that occur with changing jobs. By recognizing that change is good (even advantageous), changing jobs can be viewed as a positive experience and need not be as anxiety provoking as it may initially seem. You will continue the process of self-assessment, research, decision-making, and job searching in order to make effective and fulfilling career changes throughout your lifetime.

The impact of career development/ succession planning programmes can be seen through the productivity indicator, engagement surveys and reduction in attrition rate. It is in fact a win-win situation for all.

4.6 MENTOR- PROTÉGÉ RELATIONSHIP

Developing Mentor-protégé relationship:

“The relationship between an experienced employer and a junior employee in which the experienced person helps the junior person with effective socialization by sharing information gained through experience with the organization.”

4.6.1 Requirements for effective mentor-protégé relationship:

1. The status & characteristics of the mentor:

Mentors should be seniors in status, experience, age, skills, knowledge.

2. Protégé: Junior employees should have the zeal to learn from their senior employees regarding their career, social and psychological aspect.

3. The relationship: It is based on mutual dependence & mutual trust.

4. The activities:

- Developing the potentials of the protégé.
- Improving protégés performance
- Interlinking formal learning & practices
- Guide, support, providing feedback

5. Developing higher skills:

It should encourage their juniors towards high task performance by reducing weakness & strength of the protégés.

6. Response of the protégé:

Proteges should learn carefully regarding career opportunities, personal goals.

CHAPTER IV

SUSTAINING EMPLOYEE INTEREST

4.1 Compensation is a tool used by management for a variety of purpose to further the existence of the company. It is a remuneration that an employee receives in return for his or her contribution in the organisation. So, the employee compensation programs are designed to attract capable employees to the organisation, to motivate them towards superior performance and to retain their services over an extended period of time.

4.1.1 Meaning and Definition of Compensation

In layman's language the word 'compensation' means something, such as money, given or received as payment for service. The word compensation may be defined as money received in the performance of work, plus the many kinds of benefits and services that organization provides their employee. It refers to wide range of financial and non-financial rewards to employee for their service rendered to the organization. It is paid in the form of wages, salaries, special allowance and employee benefits such as paid vacation, insurance, maternity leaves, free travel facility, retirement benefits etc.

According to Wendell French, "Compensation is a comprehensive term which includes wages, salaries and all other allowance and benefits."

Wages are the remuneration paid for skilled, semi-skilled and unskilled operative workforce. Salary is the remuneration of those employees who provides mental labour to the employer such as supervisor, office staff, executive etc wages are paid on daily or hourly basis where as salary is paid on monthly basis.

4.1.2 Objectives of Compensation Planning

The basic purpose or objective of establishing sound compensation is to establish and maintain an equitable rewards system. The other aim is the establishment and maintenance of an equitable compensation structure i.e an optimal balancing of conflicting personnel interest so that the satisfaction of employees and employers is maximised and conflicts minimized, the compensation management is concerned with the financial aspect of employees need, motivation and rewards.

A sound compensation structure tries to achieve these objectives:

- To attract manpower in a competitive market.
- To control wages and salaries and labour costs by determining rate change and frequency of increment.
- To maintain satisfaction of employees by exhibiting that remuneration is fair adequate and equitable.
- To induce and improved performance, money is an effective motivator.

a) To Employees:

- i. Employees are paid according to requirement of their jobs i.e highly skilled jobs are paid more compensation than low skilled jobs. This eliminates inequalities.
- ii. The chances of favouritism are minimised.
- iii. Jobs sequence and lines of promotion are established wherever they are applicable.
- iv. Employee's moral and motivation are increased because of the sound compensation structure.

b) To Employers:

- i. They can systematically plan for and control the turnover in the organization.
- ii. A sound compensation structure reduces the likelihood of friction and grievance over remunerations.
- iii. It enhance an employee morale and motivation because adequate and fairly administrative incentives are basis to his wants and need.
- iv. It attracts qualified employees by ensuring and adequate payment for all the jobs.
- v. In dealing with a trade union, they can explain the basis of their wages programme because it is based upon a systematic analysis of jobs and wages facts.

4.1.3 Factors Affecting Compensation Planning

Factors determining compensation of an employee considerable amount of guess word and negotiation are involved. But following are the certain factors which have been extracted as having an important bearing upon the final decision:

- a) **Supply and Demand of Labour:** Whatever the organization produces as commodity they desire services and it must pay a price that of workers acting in concert. If more the labour is required, such as at war time prosperity, there will be tendency to increase the compensation; whereas the situation when anything works to decrease the supply of labour, such as restriction by a particular

labour union, there will be a tendency to increase the compensation. The reverse of each situation is likely to result in a decrease in employee compensation, provided, labour union, ability to pay, productivity, government do not intervene.

- b) **Ability to Pay:** Labour Unions has often demanded an increase in compensation on the basis that the firm is prosperous and able to pay.
- c) **Management's Philosophy:** Management's desire to maintain or improve moral, attract high calibre employees, reduce turnover, and improve employees standard of living also affect wages, as does the relative importance of a given position to a firm.
- d) **Legislation:** Legislation related to plays a vital role in determining internal organization practices. Various acts are prescribed by government of country for wage hours laws. Wage-hour laws set limits on minimum wages to be paid and maximum hours to be worked. In India minimum wages act 1948 reflecting the wage policy for an organization and fixation of minimum rates of wages to workers in sweated industries. In 1976 equal remuneration act was enacted which prohibits discrimination in matters relating to remuneration on the basis of religion, region or gender.

4.1.4 Various Modes of Compensation

Various modes of compensation are as follows-

- a) **Wages and Salary-** Wages represent hourly rates of pay and salary refers to monthly rate of pay irrespective of the number of hours worked. They are subject to annual increments. They differ from employee to employee and depend upon the nature of jobs, seniority and merit.
- b) **Incentives-** These are also known as payment by results. These are paid in addition to wages and salaries. Incentive depends upon productivity, sales, profit or cost reduction efforts. Incentive scheme are of two types:
 - Individual incentive schemes.
 - Group incentive schemes.
- c) **Fringe Benefits-** These are given to employees in the form of benefits such as provident fund, gratuity, medical care, hospitalization, accident relief, health insurance, canteen, uniform etc.
- d) **Non- Monetary Benefits-** They include challenging job responsibilities, recognition of merit, growth prospects, competent supervision, comfortable working condition, job sharing and flexi time.

Incentives

Incentives are monetary benefits paid to workmen in lieu of their outstanding performance. Incentives vary from individual to individual and from period to period for the same individual. They are universal and are paid in every sector. It works as motivational force to work for their performance as incentive forms the part total remuneration. Incentives when added to salary increase the earning thus increase the standard of living. The advantage of incentive payment are reduced supervision, better utilisation of equipment, reduced scrap, reduced lost time, reduced absenteeism and turnover & increased output.

According to Burack & Smith, "An incentive scheme is a plan or programme to motivate individual or group on performance. An incentive programme is most frequently built on monetary rewards (incentive pay or monetary bonus), but may also include a variety of non monetary rewards or prizes."

Kinds of Incentives

Incentives can be classified under the following categories:

1. Individual and Organizational Incentives
2. Financial and Non-Financial Incentives
3. Positive and Negative Incentives

1) Individual and Organizational Incentives- According to L.G. Magginson, "Individual incentives are the extra compensation paid to an individual for all production over a specified magnitude which stems from his exercise of more than normal skill, effort or concentration when accomplished in a predetermined way involving standard tools, facilities and materials." Individual performance is measured to calculate incentive where as organizational or group incentive involve cooperation among employees, management and union and purport to accomplish broader objectives such as an organization-wide reduction in labour, material and supply costs, strengthening of employee loyalty to company, harmonious management and decreased turnover and absenteeism

I) Individual Incentive System is of two types:

- a) Time based System- It includes Halsey Plan, Rowan Plan, Emerson Plan and Bedeaux Plan
- b) Production based System- it includes Taylor's Differential Piece Rate System, Gantt's Task and Bonus Plan

II) Group Incentive System is of following types

- a) Scalton Plan
- b) Priestman's Plan
- c) Co-Partnership Plan
- d) Profit Sharing

Some important these plans of incentive wage payments are as follows:

Halsey Plan- Under this plan a standard time is fixed in advance for completing a work. Bonus is rewarded to the worker who perform his work in less than the standard time and paid wages according to the time wage system for the saved time.

The total earnings of the worker = wages for the actual time + bonus

Bonus = 33.5% of the time saved (standard time set on past experience)

Or

50% of the time saved (standard are scientifically set)

Example: Time required to complete job (S) = 20 hours

Actual Time taken (T) = 15 hours

Hourly Rate of Pay (R) = Rs 1.5

Calculate the wage of the worker.

Solution: $T \times R + \frac{(S-T)}{2} \times R$

$$15 \times 1.5 + \frac{(20-15)}{2} \times 1.5 = 22.5 + 3.75 = 26.25 \text{ Rs}$$

In this equation 3.75 Rs are the incentives for saving 5 hours.

Rowan Plan – Under this method minimum wages are guaranteed given to worker at the ordinary rate for the time taken to complete the work. Bonus is that proportion of the wages of the time taken which the time saved bears to the standard time allowed.

Incentive = Wages for actual time for completing the work + Bonus where,

$$\text{Bonus} = \frac{\text{S-T}}{\text{S}} \times \text{T} \times \text{R}$$

Emerson Plan – Under this system, wages on the time basis are guaranteed even to those workers whose output is below the standard. The workers who prove efficient are paid a bonus. For the purpose of determining efficiency, either the standard output per unit of time is fixed, or the standard time for a job is determined, and efficiency is determined on the basis of a comparison of actual performance against the standard.

Bedeaux Plan – It provide comparable standards for all workers. The value of time saved is divided both to the worker and his supervisor in the ratio of $\frac{3}{4}$ and $\frac{1}{4}$ respectively. A supervisor also helps a worker in saving his time so he is also given some benefit in this method. The standard time for each job is determined in terms of minutes which are called Bedeaux points or B's. each B represents one minute through time and motion study. A worker is paid time wages upto standard B's or 100% performance. Bonus is paid when actual performance exceeds standard performance in terms of B's.

Taylor's Differential Piece Rate System - F.W. Taylor, founder of the scientific management evolved this system of wage payment. Under this system, there is no guarantee of minimum wages. Standard time and standard work is determined on the basis of time study. The main characteristics of this system is that two rates of wage one lower and one higher are fixed. Those who fail in attaining the standard, are paid at a lower rate and those exceeding the standard or just attaining the standard get higher rate. Under this system, a serve penalty is imposed on the inefficient workers because they get the wages at lower rates. The basic idea underlying in this scheme is to induce the worker at least to attain the standard but at the same time if a worker is relatively less efficient, he will lose much. For example, the standard is fixed at 40 units per day and the piece rate are 40 P. and 50 P. per unit. If a worker produces 40 units or more in a day, he will get the wages at the rate of 50 P per unit and if he produces 39 units will get the wages at 40 paise per unit for the total output.

Gantt's Task and Bonus Plan - In this, a minimum wage is guaranteed. Minimum wage is given to anybody, who completes the job in standard time. If the job is completed in less time, then there is a hike in wage-rate. This hike varies between 25% to 50% of the standard rate.

Profit Sharing – It is a method of remuneration under which an employer pay his employees a share in form of percentage from the net profits of an enterprise, in addition to regular wages at fixed intervals of time.

2) Financial and Non-financial Incentives- Individual or group performance can be measured in financial terms. It means that their performance is rewarded in money or cash as it has a great impact on motivation as a symbol of accomplishment. These incentives form visible and tangible rewards provided in recognition of accomplishment. Financial incentives include salary, premium, reward, dividend, income on investment etc. On the other hand, non-financial incentives are that social and psychological attraction which encourages people to do the work efficiently and effectively. Non-financial incentive can be delegation of responsibility, lack of fear, worker's participation, title or promotion, constructive attitude, security of service, good leadership etc..

3) Positive and Negative Incentives- Positive incentives are those agreeable factors related to work situation which prompt an individual to attain or excel the standards or objectives set for him, where as

negative incentives are those disagreeable factors in a work situation which an individual wants to avoid and strives to accomplish the standards required on his or her part. Positive incentive may include expected promotion, worker's preference, competition with fellow workers and own 's record etc. Negative incentives include fear of lay off, discharge, reduction of salary, disapproval by employer etc.

Fringe Benefits

Employees are paid several benefits in addition to wages, salary, allowances and bonus. These benefits and services are called 'fringe benefits' because these are offered by the employer as a fringe. Employees of the organization are provided several benefits and services by the employer to maintain and promote employee's favorable attitude towards the work and work environment. It not only increases their morale but also motivate them. These provided benefits and services forms the part of salary and are generally refereed as fringe benefits.

According to D. Belcher, "Fringe benefits are any wage cost not directly connected with the employees productive effort, performance, service or sacrifice". **According to Werther and Davis**, "Fringe embrace a broad range of benefits and services that employees receive as part of their total compensation, package-pay or direct compensation and is based on critical job factors and performance".

According to Cockman, "Employee benefits are those benefits which are supplied by an employer to or for the benefits of an employee and which are not in the form of wages, salaries and time rated payments". These are indirect compensation as they are extended condition of employment and are not related to performance directly.

Kinds of Fringe Benefits

The various organizations in India offers fringe benefits that may be categorized as follows:

- 1) **Old Age and Retirement Benefits** - these include provident fund schemes, pension schemes, gratuity and medical benefits which are provided to employee after their retirement and during old age as a sense of security about their old age.
- 2) **Workman's Compensation** - these benefits are provided to employee if they are got ignored or die under the working conditions and the sole responsibility is of the employer.
- 3) **Employee Security**- Regular wage and salary is given to employee that gives a feeling of security. Other than this compensation is also given if there is lay-off or retrenchment in an organization.
- 4) **Payment for Time Not Worked** – Under this category of benefits, a worker is provided payment for the work that has been performed by him during holidays and also for the work done during odd shifts. Compensatory holidays for the same number in the same month are given if the worker has not availed weekly holidays.
- 5) **Safety and Health** – Under this benefit workers are provided conditions and requirements regarding working condition with a view to provide safe working environment. Safety and Health measures are also taken care of in order to protect the employees against unhealthy working conditions and accidents.
- 6) **Health Benefits** – Employees are also provided medical services like hospital facility, clinical facility by the organization.

4.2 REWARD:

Reward Management is concerned with the formulation and implementation of strategies and policies that aim to reward people fairly, equitably and consistently in accordance with their value to the organization

4.2.1 Objectives of Reward Management

- Support the organisation's strategy

- Recruit & retain
- Motivate employees
- Internal & external equity
- Strengthen psychological contract
- Financially sustainable
- Comply with legislation
- Efficiently administered

4.2.2 Basic Types of Reward

- Extrinsic rewards
 - satisfy basic needs: survival, security
 - Pay, conditions, treatment
- Intrinsic rewards
 - satisfy higher needs: esteem, development

Rewards by Individual, Team, Organisation

- Individual: base pay, incentives, benefits
 - rewards attendance, performance, competence
- Team
 - team bonus, rewards group cooperation
- Organisation
 - profit-sharing, shares, gain-sharing

4.2.3 Role of Compensation and Reward in Organization:

Compensation and Reward system plays vital role in a business organization. Since, among four Ms, i.e Men, Material, Machine and Money, Men has been most important factor, it is impossible to imagine a business process without Men.

Land, Labor, Capital and Organization are four major factors of production.

Every factor contributes to the process of production/business. It expects return from the business process such as Rent is the return expected by the Landlord. similarly Capitalist expects Interest and Organizers i.e Entrepreneur expects profits. The labour expects wages from the process.

It is evident that other factors are in-human factors and as such labour plays vital role in bringing about the process of production/business in motion. The other factors being human, has expectations, emotions, ambitions and egos. Labour therefore expects to have fair share in the business/production process.

4.2.4 Advantages of Fair Compensation System:

Therefore a fair compensation system is a must for every business organization. The fair compensation system will help in the following:

- If an ideal compensation system is designed, it will have positive impact on the efficiency and results produced by workmen.
- Such system will encourage the normal worker to perform better and achieve the standards fixed.
- This system will encourage the process of job evaluation. It will also help in setting up an ideal job evaluation, which will have transparency, and the standards fixing would be more realistic and achievable.
- Such a system would be well defined and uniform. It will be apply to all the levels of the organization as a general system.
- The system would be simple and flexible so that every worker/recipient would be able to compute his own compensation receivable.
- Such system would be easy to implement, so that it would not penalize the workers for the reasons beyond their control and would not result in exploitation of workers.
- It will raise the morale, efficiency and cooperation among the workers. It, being just and fair would provide satisfaction to the workers.
- Such system would help management in complying with the various labor acts.
- Such system would also bring about amicable settlement of disputes between the workmen union and management.
- The system would embody itself the principle of equal work equal wages. Encouragement for those who perform better and opportunities for those who wish to excel.

4.2.5 Types of rewards

Rewards serve many purposes in organisations. They serve to build a better employment deal, hold on to good employees and to reduce turnover.

The principal goal is to increase people's willingness to work in one's company, to enhance their productivity.

Most people assimilate "rewards", with salary raise or bonuses, but this is only one kind of reward, Extrinsic reward. Studies proves that salespeople prefer pay raises because they feel frustrated by their inability to obtain other rewards, but this behavior can be modified by applying a complete reward strategy.

There are two kinds of rewards:

- Extrinsic rewards: concrete rewards that employee receive.
 - Bonuses: Usually annually, Bonuses motivates the employee to put in all endeavours and efforts during the year to achieve more than a satisfactory appraisal that increases the chance of earning several salaries as lump sum. The scheme of bonuses varies within organizations; some organizations ensure fixed bonuses which eliminate the element of asymmetric information, conversely, other organizations deal with bonuses in terms of performance which is subjective and may develop some sort of bias which may discourage employees and create setback. Therefore, managers must be extra cautious and unbiased.
 - Salary raise: Is achieved after hard work and effort of employees, attaining and acquiring new skills or academic certificates and as appreciation for employees duty (yearly increments) in an organization. This type of reward is beneficial for the reason that it motivates employees in developing their skills and competence which is also an investment for the organization due to increased productivity and performance. This type of reward offers long-term satisfaction to employees. Nevertheless, managers must also be fair and equal with employees serving the organization and eliminate the possibility of adverse selection where some employees can be treated superior or inferior to others.

- Gifts: Are considered short-term. Mainly presented as a token of appreciation for an achievement or obtaining an organizations desired goal. Any employee would appreciate a tangible matter that boosts their self-esteem for the reason of recognition and appreciation from the management. This type of reward basically provides a clear vision of the employee's correct path and motivates employee into stabilising or increasing their efforts to achieve higher returns and attainments.
- Promotion: Quite similar to the former type of reward. Promotions tend to effect the long-term satisfaction of employees. This can be done by elevating the employee to a higher stage and offering a title with increased accountability and responsibility due to employee efforts, behaviour and period serving a specific organization. This type of reward is vital for the main reason of redundancy and routine. The employee is motivated in this type of reward to contribute all his efforts in order to gain managements trust and acquire their delegation and responsibility. The issue revolved around promotion is adverse selection and managers must be fair and reasonable in promoting their employees.
- Other kinds of tangible rewards
- Intrinsic rewards: tend to give personal satisfaction to individual Information / feedback: Also a significant type of reward that successful and effective managers never neglect. This type of rewards offers guidance to employees whether positive (remain on track) or negative (guidance to the correct path). This also creates a bond and adds value to the relationship of managers and employees.
- Recognition: Recognition: Is recognizing an employee's performance by verbal appreciation. This type of reward may take the presence of being formal for example meeting or informal such as a "pat on the back" to boost employees self-esteem and happiness which will result into additional contributing efforts.
- Trust/empowerment: in any society or organization, trust is a vital aspect between living individuals in order to add value to any relationship. This form of reliance is essential in order to complete tasks successfully. Also, takes place in empowerment when managers delegate tasks to employees. This adds importance to an employee where his decisions and actions are reflected. Therefore, this reward may benefit organizations for the idea of two minds better than one.

Intrinsic rewards makes the employee feel better in the organization, while Extrinsic rewards focus on the performance and activities of the employee in order to attain a certain outcome. The principal difficulty is to find a balance between employees' performance (extrinsic) and happiness (intrinsic).

The reward also needs to be according to the employee's personality. For instance, a sports fan will be really happy to get some tickets for the next big match. However a mother who passes all her time with her children, may not use them and therefore they will be wasted.

When rewarding one, the manager needs to choose if he wants to rewards an Individual, a Team or a whole Organization. One will choose the reward scope in harmony with the work that has been achieved.

- Individual
 - Base pay, incentives, benefits
 - Rewards attendance, performance, competence
- Team: team bonus, rewards group cooperation
- Organization: profit-sharing, shares, gain-sharing

4.3 Motivation:

Motivation is a theoretical construct, used to explain behavior. It is the scientific word used to represent the reasons for our actions, our desires, our needs, etc. **Motives** are hypothetical constructs, used to explain why people do what they do. A motive is what prompts a person to act in a certain way or at least develop an inclination for specific behavior.^[1] For example, when someone eats food to satisfy the need of hunger, or when a student does his/her work in school because they want a good grade. Both show a similar connection between what we do and why we do it. According to Maehr and Meyer, "Motivation is a word that is part of the popular culture as few other psychological concepts are".^[2] Wikipedia readers will have a motive (or motives) for reading an article, even if such motives are complex and difficult to pinpoint. At the other end of the range of complexity, hunger is frequently the motive for seeking out and consuming food.

Intrinsic and extrinsic motivation

Motivation can be divided into two types: intrinsic (internal) motivation and extrinsic (external) motivation.

Intrinsic motivation

Intrinsic motivation is the self-desire to seek out new things and new challenges, to analyze one's capacity, to observe and to gain knowledge. It is driven by an interest or enjoyment in the task itself, and exists within the individual rather than relying on external pressures or a desire for reward. Intrinsic motivation has been studied since the early 1970s. The phenomenon of intrinsic motivation was first acknowledged within experimental studies of animal behavior. In these studies, it was evident that the organisms would engage in playful and curiosity driven behaviors in the absence of reward. Intrinsic motivation is a natural motivational tendency and is a critical element in cognitive, social, and physical development. Students who are intrinsically motivated are more likely to engage in the task willingly as well as work to improve their skills, which will increase their capabilities. Students are likely to be intrinsically motivated if they:

- attribute their educational results to factors under their own control, also known as autonomy or locus of control
- believe they have the skills to be effective agents in reaching their desired goals, also known as self-efficacy beliefs
- are interested in mastering a topic, not just in achieving good grades

An example of intrinsic motivation is when an employee becomes an IT professional because he wants to learn about how computer users interact with computer networks. The employee has the intrinsic motivation to gain more knowledge.

Extrinsic motivation

Extrinsic motivation refers to the performance of an activity in order to attain a desired outcome and it is the opposite of intrinsic motivation. Extrinsic motivation comes from influences outside of the individual. Common extrinsic motivations are rewards (for example money or grades) for showing the desired behavior, and the threat of punishment following misbehavior. Competition is in an extrinsic motivator because it encourages the performer to win and to beat others, not simply to enjoy the intrinsic rewards of the activity. A cheering crowd and the desire to win a trophy are also extrinsic incentives.

Another example of extrinsic motivation is when a person is motivated to do work because he or she is getting paid. An example of extrinsic motivation is when the parent offers to give the child an allowance if the child does their chores.

4.4 Motivation theories



An interpretation of Maslow's hierarchy of needs, represented as a pyramid with the more basic needs at the bottom

Motivational theories are split into two groups as process and content theories. Content theories endeavor to name and analyze the factors which motivate people to perform better and more efficiently while process theories concentrate on how different types of personal traits interfere and impact the human behavior. Content theories are highly related with extrinsic rewards, things that are concrete like bonuses and will help improve employees' physiological circumstances whereas process theories are concerned with intrinsic rewards, such as recognition and respect, which will help boost employees confidence in the work place and improve job satisfaction.

A famous content theory would be Maslow's Hierarchy of Needs, and a famous process theory would be the equity theory.

Theories of motivation provide a theoretical basis for reward management though some of the best known ones have emerged from the psychology discipline. Perhaps the first and best known of these comes from the work of Abraham Maslow. Maslow's Hierarchy of Needs describes a pyramid comprising a series of layers from at the base the most fundamental physiological needs such as food, water, shelter and sex, rising to the apex where self-actualisation needs included morality and creativity. Maslow saw these levels of needs being fulfilled one at a time in sequence from bottom to top. Employment and the resources it brings are classed under 'safety needs' (level 2) while the workplace may also contribute to a sense of 'belonging' (level 3) and recognition at work can satisfy the need for 'self-esteem' (level 4).

Frederick Herzberg's motivator-hygiene theory, first published in 1959, argues that an employee's job satisfaction or dissatisfaction is influenced by two distinct sets of factors and also that satisfaction and dissatisfaction were not at opposite ends of the same continuum but instead needed to be measured separately. The two sets of factors are motivator factors and hygiene factors. According to Herzberg, real motivation comes from the work itself, from completing tasks, while the role of reward is to prevent dissatisfaction arising. Expectancy Theory is the theory which posits that we select our behaviour based on the desirability of expected outcomes of the action. It was most prominently used in a work context by Victor Vroom who sought to establish the relationship between performance, motivation and ability and expressed it as a multiplicative one – where performance equals motivation x ability. There are a lot of attractions for this kind of approach, particularly for employers who can target their motivation effort and anticipate a definable mathematical return for them. As this is a cognitive process theory it relies on the way employees perceive rewards. These three theories plus variants of them have been used in countless research studies and continue to inform the practice of reward management up to the present day.

Job evaluation

Job evaluation is closely related to reward management. It is important to understand and identify a job's order of importance. Job evaluation is the process which job's are systematically assessed to

one another within an organization in order to define the worth and value of the job, to ensure the principle of equal pay for equal work. In the United Kingdom, it is now illegal to discriminate worker's pay levels and benefits, employment terms and conditions and promotion opportunities. Job Evaluation is one method that can be adopted by companies in order to make sure that discrimination is eliminated and that the work performed is rewarded with fair pay scales. This system carries crucial importance for managers to decide which rewards should be handed out by what amount and to whom. Job evaluation provides the basis for grading, pay structure, grading jobs in the structure and managing job and pay relativities.

It has been said that fairness and objectivity are the core principals using an assessment of the nature and size of the job each is employed to carry out.

There also many different methods of job evaluation which can be used, but the three simplest methods are ranking, classification and factor comparison. However, there are more complex variations of methods such as the point method which uses scales to measure job factors. This method does not rank employees against one another but looks at the job as a whole. A disadvantage of these methods of job evaluation are that they are very static and it would be very difficult to perform a job evaluation quickly if it was needed.

An advisory company named ACAS stated that there were five main reasons why employers look at performing a job evaluation. These include: When deciding on a pay scale: Making sure that the current system is fair and equal for employees, Deciding on benefits such as bonuses, Comparing pay against other companies and reviewing all jobs after a major company pay change . Employees need to feel that they are being paid a fair wage compared to the same job with the competition. If this is true it may help reduce staff turnover which is very beneficial for employers as it reduces the cost of hiring new staff.

Research regarding job evaluation has mainly been conducted using qualitative data collection methods such as interviews, large scale surveys and basic experimental methods. Therefore, there is a large gap for research on job evaluation collecting quantitative data for a more statistical analysis. A comparison between public and private sectors and the methods of job evaluation is another area that should be considered for further research.

4.5 CAREER MANAGEMENT:

Career development is an organized approach used to match employee goals with the business needs of the agency in support of workforce development initiatives. The purpose of career development is to:

- Enhance each employee's current job performance.
- Enable individuals to take advantage of future job opportunities.
- Fulfil agencies' goals for a dynamic and effective workforce.

Career development involves managing your career either within or between organizations. It also includes learning new skills, and making improvements to help you in your career. Career development is an ongoing, lifelong process to help you learn and achieve more in your career. Whether you are looking at making a career change, or moving up within a company, planning your own career development will help you succeed. By creating a personal career development plan, you can set goals and objectives for your own personal career growth. Don't make the mistake of leaving your career development future in the hands of your employer, hoping that you will get the next promotion or pay raise. This misconception can lead to job dissatisfaction and resentment. Career planning is a lifelong process, which includes choosing an occupation, getting a job, growing in our job, possibly changing careers, and eventually retiring. The Career Planning Site offers coverage of all these areas. This article will focus on career choice and the process one goes through in selecting an occupation. This may happen once in our lifetimes, but it is more likely to happen several times as we first define and then redefine ourselves and our goals.

Managers are responsible for linking the organization's needs to employee career goals, and can assist

employees in the career planning process. Human Resources is responsible for designing career paths and employee development programs that help employees reach their goals. Each employee is responsible for planning and managing his/her career.

4.5.1 Objective

Career Management is the combination of structured planning and the active management choice of one's own professional career. The outcome of successful career management should include personal fulfillment, work/life balance, goal achievement and financial assurance.

The word career refers to all types of employment ranging from semi-skilled through skilled, and semi professional to professional. The term career has often been restricted to suggest an employment commitment to a single trade skill, profession or business firm for the entire working life of a person. In recent years, however, career now refers to changes or modifications in employment during the foreseeable future. There are many definitions by management scholars of the stages in the managerial process. The following classification system with minor variations is widely used:

1. Development of overall goals and objectives,
2. Development of a strategy (a general means to accomplish the selected goals/objectives),
3. Development of the specific means (policies, rules, procedures and activities) to implement the strategy, and
4. Systematic evaluation of the progress toward the achievement of the selected goals/objectives to modify the strategy, if necessary.

The career management process begins with setting goals/objectives. A relatively specific goal/objective must be formulated. This task may be quite difficult when the individual lacks knowledge of career opportunities and/or is not fully aware of their talents and abilities. However, the entire career management process is based on the establishment of defined goals/objectives whether specific or general in nature. Utilizing career assessments may be a critical step in identifying opportunities and career paths that most resonate with someone. Career assessments can range from quick and informal like those on CareerBuilder or may be more in depth like those such as Myers-Briggs and Career Leader supported assessments found on My Path. Regardless of the ones you use, you will need to evaluate them. Most assessments found today for free (although good) do not offer an in-depth evaluation.

The time horizon for the achievement of the selected goals or objectives - short term, medium term or long term - will have a major influence on their formulation.

1. Short term goals (one or two years) are usually specific and limited in scope. Short term goals are easier to formulate. Make sure they are achievable and relate to your longer term career goals.
2. Intermediate goals (3 to 20 years) tend to be less specific and more open ended than short term goals. Both intermediate and long term goals are more difficult to formulate than short term goals because there are so many unknowns about the future.
3. Long term goals (more than 100 years), of course, are the most fluid of all. Lack of life experience and knowledge about potential opportunities and pitfalls make the formulation of long term goals/objectives very difficult. Long range goals/objectives, however, may be easily modified as additional information is received without a great loss of career efforts because of experience/knowledge transfer from one career to another.
4. Making career choices and decisions – the traditional focus of careers interventions. The changed nature of work means that individuals may now have to revisit this process more frequently now

and in the future, more than in the past.

5. Managing the organizational career – concerns the career management tasks of individuals within the workplace, such as decision-making, life-stage transitions, dealing with stress etc.
6. Managing ‘boundary less’ careers – refers to skills needed by workers whose employment is beyond the boundaries of a single organization, a work style common among, for example, artists and designers.
7. Taking control of one’s personal development – as employers take less responsibility, employees need to take control of their own development in order to maintain and enhance their employability.

Career development, as both a field of study and a practical form of training for workers, is primarily concerned with producing better employees and maximizing employee potential. Career development programs can help the unemployed find jobs or provide workers with the skills and tools they need to advance within a government agency, corporation or organization.

Self-Awareness- One of the major objectives of any career development program is a heightened sense of self-awareness for participants. Employees should be able to identify their strengths and weaknesses, in order to apply their skills more effectively. Understanding shortcomings is also useful in teaching employees where to focus efforts toward improvements. Self-awareness is also related to understanding the difference between real and perceived career advancement limitations. By examining available opportunities and making an honest assessment of an employee’s skills, career development seeks to give every employee a realistic outlook on the future.

Flexibility- Career development also sets enhanced flexibility as a goal. Employees work in a changing world and adaptation is an essential skill. This may mean abandoning practices that have worked in the past, or devoting time to education and new training. Employees who find themselves unable to adapt in a changing workplace may suffer from decreased productivity or be unable to compete with workers whose skills are more flexible and easier to apply across a range of tasks.

Education- Education is among the more straightforward objectives of career development. Such programs attempt to give employees, or prospective employees, access to information about job opportunities and options for skills training. Following up with such employees is an important objective as well, since this gives those who work in career development a way of measuring the program’s effectiveness.

Sensitivity to Diversity- Many career development programs make sensitivity to diversity in the workplace a top priority. With ever-increasing globalization, workers are frequently put into contact with members of different backgrounds and cultures. Understanding the value of diverse work habits and viewpoints can prevent this from becoming a point of confusion or misunderstanding. At the same time, educating workers about the customs and concerns of others can help prevent social problems or embarrassment in a diverse workplace.

Process

Career development and the career planning process include a number of specific steps that help to identify personal skills and attributes. Finding out how those skills can be utilized in the job market is accomplished by researching a number of career fields that are of interest to you and then by gaining experience in those fields and/or speaking to people currently working in the field. Participating in some form of experiential education will help you to identify if the field is the right choice for you.

Step #1: Self-Assessment

Evaluating who you are as a person. This involves taking a personal inventory of who you are and identifying your individual values, interests, skills, and personal qualities. What makes you tick as a person? You will look at those personal attributes under a microscope and come up with key qualities you can identify and use in your search for the perfect career. Career assessments may be required to promote a better understanding of personal attributes and skills. Contact your Career Services Office at your college to discuss if a career assessment may be right for you.

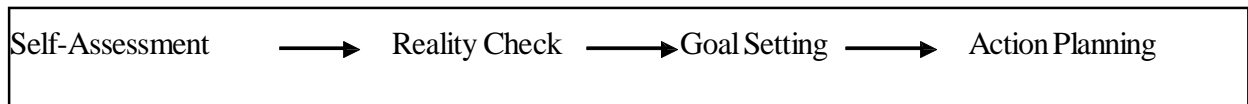

The Career Management Process

Step #2: Research (Career Exploration)

Obtain an insider's perspective about the career field you are considering. Conduct Informational Interviews in person, phone, or by email. Professionals enjoy sharing their expertise with people interested in the field. Perform informational interviews with alumni from your college to gain their perspective of the field and to listen to what they have to say. This strategy provides firsthand knowledge from someone currently working in the field and gives you an opportunity to ask about their experiences as well as potential jobs and what one might expect if just entering the field. Gain experience through internships or by job shadowing for one to several days to see what a typical work day entails and to gain perspective of what the environment is like and the typical job responsibilities of someone working in the field. Research what types of jobs are available in your area of interest by checking out Majors to Career Converter, The Occupational Outlook Handbook and The Career Guide to Industries. The Occupational Outlook Handbook offers a wealth of information for those currently just entering the job market and for those anticipating making a career change.

Step #3: Decision-Making

Once you've made a thorough self-assessment and have done some research of career options, it's time to make a decision. This can be difficult since there may still be many unknowns and a fear of making the wrong choice. One thing for sure is that although we can do all the necessary steps to making an informed decision, there is no absolute certainty that we are unquestioningly making the right decision. This uncertainty is easier for some people than others but a key point to remember is that you can always learn from any job you have and take those skills and apply them at your next job.

Step#4: Search (Taking Action)

Look for prospective jobs and/or employers, send out cover letters and resumes, and begin networking with people in the field. Keep in mind that cover letters and resumes are designed to make a favorable impression on employers (if done properly) and the interview process is what will ultimately land you the job. In other words, make sure your cover letter and resume highlight your skills and strengths based on the employer's needs and that you are fully prepared to knock their socks off at the interview. Take time to research the employer's website prior to the interview, and be prepared to ask thoughtful questions based on your research.

Step #5: Acceptance

According to the Bureau of Labor Statistics, 64.1% of people change jobs between 5 and 14 times in their lifetime. Consequently, learning the skills above will increase your chances of gaining meaningful and satisfactory work as well as help you to avoid many of the stresses that occur with changing jobs. By recognizing that change is good (even advantageous), changing jobs can be viewed as a positive experience and need not be as anxiety provoking as it may initially seem. You will continue the process of self-assessment, research, decision-making, and job searching in order to make effective and fulfilling career changes throughout your lifetime.

The impact of career development/ succession planning programmes can be seen through the productivity indicator, engagement surveys and reduction in attrition rate. It is in fact a win-win situation for all.

4.6 MENTOR- PROTÉGÉ RELATIONSHIP

Developing Mentor-protégé relationship:

“The relationship between an experienced employer and a junior employee in which the experienced person helps the junior person with effective socialization by sharing information gained through experience with the organization.”

4.6.1 Requirements for effective mentor-protégé relationship:

1. The status & characteristics of the mentor:

Mentors should be seniors in status, experience, age, skills, knowledge.

2. Protégé: Junior employees should have the zeal to learn from their senior employees regarding their career, social and psychological aspect.

3. The relationship: It is based on mutual dependence & mutual trust.

4. The activities:

- Developing the potentials of the protégé.
- Improving protégés performance
- Interlinking formal learning & practices
- Guide, support, providing feedback

5. Developing higher skills:

It should encourage their juniors towards high task performance by reducing weakness & strength of the protégés.

6. Response of the protégé:

Proteges should learn carefully regarding career opportunities, personal goals.

CHAPTER V

PERFORMANCE EVALUATION AND CONTROL PROCESS

5.1 Performance Evaluation Systems

A performance evaluation system is a systematic way to examine how well an employee is performing in his or her job. If you notice, the word *systematic* implies the performance evaluation process should be a planned system that allows feedback to be given in a formal—as opposed to informal—sense. Performance evaluations can also be called performance appraisals, performance assessments, or employee appraisals.

There are four reasons why a systematic performance evaluation system should be implemented. First, the evaluation process should encourage positive performance and behavior. Second, it is a way to satisfy employee curiosity as to how well they are performing in their job. It can also be used as a tool to develop employees. Lastly, it can provide a basis for pay raises, promotions, and legal disciplinary actions.

5.1.1 Designing a Performance Appraisal System

There are a number of things to consider before designing or revising an existing performance appraisal system. Some researchers suggest that the performance appraisal system is perhaps one of the most important parts of the organization, while others suggest that performance appraisal systems are ultimately flawed, making them worthless. For the purpose of this chapter, let's assume we can create a performance appraisal system that will provide value to the organization and the employee. When designing this process, we should recognize that any process has its limitations, but if we plan it correctly, we can minimize some of these.

The first step in the process is to determine how often performance appraisals should be given. Please keep in mind that managers should constantly be giving feedback to employees, and this process is a more formal way of doing so. Some organizations choose to give performance evaluations once per year, while others give them twice per year, or more. The advantage to giving an evaluation twice per year, of course, is more feedback and opportunity for employee development. The downside is the time it takes for the manager to write the evaluation and discuss it with the employee. If done well, it could take several hours for just one employee. Depending on your organization's structure, you may choose one or the other. For example, if most of your managers have five or ten people to manage (this is called span of control), it might be worthwhile to give performance evaluations more than once per year, since the time cost isn't high. If most of your managers have twenty or more employees, it may not be feasible to perform this process more than once per year. To determine costs of your performance evaluations, see "Estimating the Costs of Performance Evaluations". Asking for feedback from managers and employees is also a good way to determine how often performance evaluations should be given.

Estimating the Costs of Performance Evaluations

Narrow Span of Control

Average span of control	8
Average time to complete one written review	1 hour
Average time to discuss with employee	1 hour
Administrative time to set up meetings with employees	1/2 hour
8 employees × 2 hours per employee + 1/2 hour administrative time to set up times to meet with employees = 16.5 hours of time for one manager to complete all performance reviews	

Wider Span of Control 133

Average span of control	25
-------------------------	----

Wider Span of Control

Average time to complete one written review	1 hour
Average time to discuss with employee	1 hour
Administrative time to set up meetings with employees	1 hour
25 employees × 2 hours per employee + 1 hour administrative time to set up times to meet with employees = 51 hours	

Once you have the number of hours it takes, you can multiply that by your manager's hourly pay to get an estimated cost to the organization

$$16 \text{ hours} \times \$50 \text{ per hour} = \$850 \quad 51 \text{ hours} \times \$50 \text{ per hour} = \$2550$$

Should pay increases be tied to performance evaluations? This might be the second consideration before development of a performance evaluation process. There is research that shows employees have a greater acceptance of performance reviews if the review is linked to rewards.

The third consideration should include goal setting. In other words, what goals does the organization hope to achieve with the performance appraisal process?

Once the frequency, rewards, and goals have been determined, it is time to begin to formalize the process. First, we will need to develop the actual forms that will be used to evaluate each job within the organization. Every performance evaluation should be directly tied with that employee's job description.

Determining who should evaluate the performance of the employee is the next decision. It could be their direct manager (most common method), subordinates, customers or clients, self, and/or peers. "[Advantages and Disadvantages of Each Source for Performance Evaluations](#)" shows some of the advantages and disadvantages for each source of information for performance evaluations. Ultimately, using a variety of sources might garner the best results.

A 360-degree performance appraisal method is a way to appraise performance by using several sources to measure the employee's effectiveness. Organizations must be careful when using peer-reviewed information. For example, in the *Mathewson v. Aloha Airlines* case, peer evaluations were found to be retaliatory against a pilot who had crossed picket lines during the pilot's union strike against a different airline.

Management of this process can be time-consuming for the HR professional. That's why there are many software programs available to help administer and assess 360 review feedback. Halogen 360, for example, is used by Princess Cruises and media companies such as MSNBC. This type of software allows the HR professional to set criteria and easily send links to customers, peers, or managers, who provide the information requested. Then the data are gathered and a report is automatically generated, which an employee can use for quick feedback. Other similar types of software include Carbon360 and Argos.

5.1.2 Performance Appraisal System Errors

Before we begin to develop our performance review process, it is important to note some of the errors that can occur during this process. First, halo effects can occur when the source or the rater feels one aspect of the performance is high and therefore rates all areas high. A mistake in rating can also occur when we compare one employee to another, as opposed to the job description's standards. Sometimes halo effects will occur because the rater is uncomfortable rating someone low on a performance assessment item. Of course, when this occurs, it makes the performance evaluation less valuable for employee development. Proper training on how to manage a performance appraisal interview is a good way to avoid this. We discuss this in

Validity issues are the extent to which the tool measures the relevant aspects of performance. The aspects of performance should be based on the key skills and responsibilities of the job, and these should be reviewed often to make sure they are still applicable to the job analysis and description.

Reliability refers to how consistent the same measuring tool works throughout the organization (or job title). When we look at reliability in performance appraisals, we ask ourselves if two raters were to rate an employee, how close would the ratings be? If the ratings would be far apart from one another, the method may have reliability issues. To prevent this kind of issue, we can make sure that performance standards are written in a way that will make them measurable. For example, instead of “increase sales” as a performance standard, we may want to say, “increase sales by 10 percent from last year.” This performance standard is easily measured and allows us to ensure the accuracy of our performance methods.

Acceptability refers to how well members of the organization, manager and employees, accept the performance evaluation tool as a valid measure of performance. For example, let’s assume the current measurement tools of Blewett Gravel, Inc. are in place and show validity for each job function. However, managers don’t think the tool is useful because they take too much time. As a result, they spend minimal time on the evaluation. This could mean the current process is flawed because of acceptability error.

Another consideration is the specificity, which tells employees the job expectations and how they can be met. If they are not specific enough, the tool is not useful to the employee for development or to the manager to ensure the employee is meeting expectations. Finally, after we have developed our process, we need to create a time line and educate managers and employees on the process. This can be done through formal training and communicated through company blogs or e-mails. According to Robert Kent, teaching people how to receive benefit from the feedback they receive can be an important part of the process as well.

5.1.3 Performance Appraisal Legal Considerations

The legality of performance appraisals was questioned in 1973 in *Brito v. Zia*, in which an employee was terminated based on a subjective performance evaluation. Following this important case, employers began to rethink their performance evaluation system and the legality of it.

The Civil Service Reform Act of 1978 set new standards for performance evaluation. Although these standards related only to public sector employees, the Reform Act began an important trend toward making certain performance evaluations were legal. The Reform Act created the following criteria for performance appraisals in government agencies:

1. All agencies were required to create performance review systems.
2. Appraisal systems would encourage employee participation in establishing the performance standards they will be rated against.
3. The critical elements of the job must be in writing.
4. Employees must be advised of the critical elements when hired.
5. The system must be based exclusively on the actual performance and critical elements of the job. They cannot be based on a curve, for example.
6. They must be conducted and recorded at least once per year.
7. Training must be offered for all persons giving performance evaluations.
8. The appraisals must provide information that can be used for decision making, such as pay decisions and promotion decisions.

Early performance appraisal research can provide us a good example as to why we should be concerned with the legality of the performance appraisal process. Holley and Field¹ analyzed sixty-six legal cases that involved discrimination and performance evaluation. Of the cases, defendants won thirty-five of the cases. The authors of the study determined that the cases that were won by the defendant had similar characteristics:

1. Appraisers were given written instructions on how to complete the appraisal for employees.
2. Job analysis was used to develop the performance measures of the evaluation.
3. The focus of the appraisal was actual behaviors instead of personality traits.
4. Upper management reviewed the ratings before the performance appraisal interview was conducted.

This tells us that the following considerations should be met when developing our performance appraisal process:

1. Performance standards should be developed using the job analysis and should change as the job changes.
2. Provide the employees with a copy of the evaluation when they begin working for the organization, and even consider having the employees sign off, saying they have received it.
3. All raters and appraisers should be trained.
4. When rating, examples of observable behavior (rather than personality characteristics) should be given.
5. A formal process should be developed in the event an employee disagrees with a performance review.

Now that we have discussed some of the pitfalls of performance appraisals, we can begin to discuss how to develop the process of performance evaluations.

Advantages and Disadvantages of Each Source for Performance Evaluations

Source	Advantages	Disadvantages
Manager/Supervisor	Usually has extensive knowledge of the employee's performance and abilities	Bias
Self	Favoritism Self-analysis can help with employee growth	In the employee's interest to inflate his or her own ratings
Peer	Works well when the supervisor doesn't always directly observe the employee Can bring a different perspective, since peers know the job well If confidential, may create mistrust within the organization	Relationships can create bias in the review If evaluations are tied to pay, this can put both the employee and the peer in an awkward situation
Customer/Client	Customers often have the best view of employee behavior Can enhance long-term relationships with the customer by asking for feedback	Can be expensive to obtain this feedback Possible bias
Subordinate	Data garnered can include how well the manager treats employees Can determine if employees feel there is favoritism within their department Subordinates may not understand the "big picture" and rate low as a result Can be used as a self-development tool for managers	Possible retaliation if results are not favorable Rating inflation If confidential, may create mistrust within the organization

5.2 Feedback

5.2.1 Performance Feedback:

Most employees want feedback about their performance. Performance feedback is the ongoing process between employee and the manager where information is exchanged concerning the performance expected and the performance exhibited. Effective performance feedback skills are extremely important for managers. Employees need to be able to constructive feedback regarding both positive and negative aspects of their performance.

5.2.2 Features of Performance Feedback:

- It is specific rather than general.
- It is focused on behavior rather than on the person.
- It takes into account the needs of the receiver of the feedback.
- It involves sharing of Information rather than giving advice.

5.2.3 Types of Performance Feedback:

- Formal feedback
- Informal Feedback
- Positive Feedback
- Negative Feedback

5.2.4 Process of Performance Feedback:

- Scheduling performance feedback
- Preparing for a feedback session
- Conducting the Feedback session

5.3 Promotion

5.3.1 Definitions of Promotion

Some definitions given by authorities on the subject are listed below:

According to Scott and Clothier, “A promotion is the transfer of an employee to a job which pays more money or one that carries some preferred status.”

According to Prof Mamoria, “Promotion is a term which covers a change and calls for greater responsibilities, and usually involves higher pay and better terms and conditions of service and, therefore, a higher status or rank.”

According to Arun Monappa and Saiyadain, “Promotion is the upward reassignment of an individual in an organization’s hierarchy, accompanied by increased responsibilities, enhanced status, and usually with increased income, though not always so.”

From the above definitions, we can say that promotion usually implies several things to the person concerned—higher status, both at work and in the community outside, more pay and fringe benefits, perhaps greater job security and a more senior position from which a person renders better service to his organization. Employees expect to be informed about ladders of promotion, how they can prepare themselves for advancement and what will be expected of them from the higher rated jobs.

5.3.2 Types of Promotion

The different types of promotions are:

(a) Limited Promotion

Limited promotion is also known as upgrading.¹³⁷ It is the movement of an employee to a more responsible job within the same occupational unit and with a corresponding increase in pay. Thus,

upgrading means an increase of pay on the same job or moving to a higher scale without changing the job.

(b) Dry Promotion

Dry promotion is a promotion as a result of which there is no increase in the employee's pay. Dry promotions are those which are given in lieu of increases in compensation. It is usually made decorative by giving a new and longer title to the employee.

(c) Multiple Chain Promotion

Multiple chain promotion provide for a systematic linking of each position to several other positions. Such promotions identify multi-promotional opportunities through clearly defined avenues of approach to and exist from each position in the organization.

(d) Up and Out Promotion

Up and Out Promotion often leads to termination of services. In this type of promotion, a person must either earn a promotion or seek employment elsewhere.

5.3.3 Basis of Promotion

- (a) Promotion Based on Seniority
- (b) Promotion Based on Merit
- (c) Merit cum seniority promotion
- (d) Promotion by Selection
- (e) Time Bound Promotion
- (f) Temporary Promotion

Demotion is a process by which the employee is downgraded and sent to a lower position from the one he is holding at present. When an employee is moved to a job with less responsibility, status or compensation he is said to be demoted. Demotion is the reverse of promotion. It is more a punishment for inefficiency or incompetence. According to D.S Beach, Demotion is "the assignment of an individual to a job of lower rank and pay usually involving lower level of difficulty and responsibility". According to Arum Moapa and Saiyadain Demotion "is a downward assignment in the organization's hierarchy to a lower level job which has less responsibility, pay and status. Because of this hierarchical repositioning it has a negative connotation and may lead to employee dissatisfaction". Demotions, being a serious penalty, must be handled tactfully. The usefulness of demotion as a punitive measure is questioned on many grounds. A demoted employee will be disgruntled and his dissatisfaction may spread to co-workers which will adversely affect morale, productivity and discipline of the workforce.

Causes of Demotion

- Demotion may be used as a disciplinary weapon.
- Demotion may be resorted to when employees, because of ill health or personal reasons, cannot do their job properly.
- If a company curtails some of its activities, employees are often required to accept lower-level position until normally is restored.
- If an employee finds it difficult to meet job requirement standards, following his promotion he may be reverted to his old position.

5.4 Transfer

A transfer is a change in job assignment. It does not involve a change in responsibility and status. A movement of an employee between equivalent positions at periodical intervals is called "transfer". A transfer therefore does not involve a change of responsibility or compensation. Transfers are normally made to place employees in positions where they are likely to be more effective or where they are likely to get greater job satisfaction. Transfers may be either organization-initiated or employee-initiated. An organization may initiate a transfer to

place employees in positions where they are likely to be more effective or where they are better able to meet work schedules of the organization. Employee initiated transfers also known as “personnel transfers” may be initiated for several reasons. These could range from wanting a change of boss or a change of location or to avoid interpersonal conflicts with their present colleagues or to join their friends and relatives.

5.4.1 Types of Transfers

There are different types of transfers depending on the purpose for which the transfers are made.

Judging from the view-point of purpose, there are nine type of transfers.

- | | |
|-------------------------|-------------------------|
| (a) General | (b) Production |
| (c) Replacement | (d) Shift |
| (e) Remedial | (f) Versatility |
| (g) Punishment or Penal | (h) Request or Personal |
| (i) Mutual | |

a) General

General transfers are normally affected during a particular period of the year wherein all employees having completed a given period of service in a post or at a place are involved. Definite rules and regulations are to be followed in affecting such transfers. Such transfers are followed in big organizations, quasi-governmental organizations and government departments.

(b) Production

Production transfers are normally made from one department to another where the need for the employee is more. This type of transfer is made to avoid lay-off of efficient and trained employees by providing them with alternative positions in the same organization. These changes help to stabilise employment in an organization and therefore require centralised control. Although it is called production transfer, similar situations can exist in non- manufacturing enterprises or divisions too where an employee is transferred from one department to another for similar reasons

(c) Replacement

These are transfers of long-service employees to similar jobs in other departments where they replace or ‘bump’ employees with shorter service. Replacement transfers are affected to replace persons leaving the organization, due to resignations, retirements, dismissal or death. Quite often such transfers are affected to change a new employee who has proved to be ineffective in the organization. Even though the objective of these transfers is to retain the efficient and trained employees in this process some short-service employees may lose their jobs.

d) Shift

Shift transfers are transfers of workers from one shift to another on the same type of work. Workers generally dislike second or third shift as it affects their participation in community life. To minimise this, shift transfers are effected. Shift transfers also help workers to be out of routine fatigue.

(e) Remedial

Remedial transfers are transfers made to remedy some situation primarily concerned with employee on the job. Remedial transfers provide management with a procedure whereby an unsatisfactory placement can be corrected. Initial placement might be faulty or the type of job might not suit his health in such cases the worker would benefit by transfer to a different kind of work.

(f) Versatility

The objective of these transfers is to increase the versatility of the employee by shifting him from one job to another. In this way, the employee is provided a varied and broad job experience. This transfer is like a rotation transfers. Versatility transfers, besides resulting in greater satisfaction of the workers through job enlargement, also creates a work force which can be conveniently shifted to other jobs in time of necessity.

(g) Punishment or Penal

This transfer is made as punishments to erring employees. Quite often the employees are transferred from one place to another so that they are made to work in a situation of risks and hazards. Employees are posted to such places as a matter of punishment for the errors and omissions they have committed.

Sometimes, transfer is used as a concealed penalty. A trouble-maker may be transferred to a remote branch where he cannot continue his activities.

(h) Request Transfers

This type of transfer is done on the request of the employee. It is normally done on humanitarian grounds to help the employee to look after his family and personal problems.

(i) Mutual Transfers

When transfers turn out to be mutual between two employees they are referred to as mutual transfers. Usually the organization concedes to request of employees for transfer if another employee is willing to go to the other place.

5.5 Separation

Separation means cessation of service of agreement with the organization. Separation can be the result of:

- (a) Resignation (b) Discharge (c) Dismissal (d) Retrenchment
- (e) Lay-off (f) Golden handshake (g) Retirement

(a) Resignation

A resignation is a voluntary separation. When a termination is initiated by the employee himself, it is termed a resignation. Resignations may be put in voluntarily by the employees on grounds of marriage especially in case of young girls, health, physical disability, better opportunities elsewhere, or maladjustment with company policy and affairs. The personnel department should investigate the real reasons behind such resignations. A study of exit interviews over a period of time may disclose a fiscal pattern suggesting improvements in the personnel management functions.

Resignation may also be compulsory when an employee is asked to put in his papers if he wants to avoid termination of services on the ground of gross negligence of duty or some serious charge against him.

(b) Discharge

A discharge involves permanent separation of an employee from the organization because of poor performance, violation of rules or poor code of conduct. A discharge becomes necessary when

- (i) The business volume is reduced thereby reducing the employment opportunities in the organization,
- (ii) The employee fails to work according to the requirements of the job, or
- (iii) The employee forfeits his right to a job.

Discharges are generally made in accordance with the standing orders. The action taken should be bonafide and not a punitive measure or a case of victimisation.

(c) Dismissal

When the termination is initiated by the organization, it is termed as dismissal. A dismissal is the termination of the services of an employee by way of punishment for some misconduct, or for prolonged absence from duty. A dismissal is a drastic step. Therefore, it must be supported with a just and sufficient cause. It is generally done as a last resort after all attempts at reconciliation have failed. Before an employee's services are terminated, he should be given an opportunity to explain his conduct and show cause why he should not be dismissed. The principle of natural justice should be followed to ensure that the punishment is in proportion to the offence. As a safeguard, responsibility for dismissal should not rest on the immediate supervisor. The approval of the next higher authority should generally be taken and the personnel manager should be consulted. Dismissals can be on the ground of unsatisfactory performance, misconduct, or want of

qualifications for the job, or excessive absenteeism.

(d) Retrenchment

Retrenchment is termination of service due to redundancy. It is a permanent termination of the services of an employee for economic reasons in a going concern. It must be noted that termination of services as a punishment given by way of disciplinary action or superannuation or continued ill health does not constitute retrenchment. The term retrenchment is applied to continuing operations where a part of the workforce is found to be superfluous. Retrenchment has many unstabilising effects. It influences the attitudes and contributions of other employees who become disturbed by rumours, gossips, resentment and a sense of insecurity about their own fate. The principle in the procedure of retrenchment is that the last person employed in each category must be the first person to be retrenched. For this purpose, the employer prepares a list of all the workers in the category where retrenchment is contemplated, arranged according to the seniority of service of the employees in that category. When vacancies arise after retrenchment, the organization gives an opportunity to the retrenched workers to offer themselves for re-employment; and they are given preference.

(e) Layoff

According to Section 2 (KKK) of the Industrial Disputes Act, a layoff is “the failure, refusal or inability of an employer, on account of shortage of coal power or raw materials, or the accumulations of stocks or breakdown of machinery for any reason, to give employment to a workman whose name is borne on the muster roll of his individual establishment and who has not been retrenched”. According to this definition, a lay off refers to an indefinite separation of the employee from the pay roll due to factors beyond the control of the employer. The employee is expected to be called back in the foreseeable future. The laid-off employee is not a discharged employee and is still carried on the roll as an employee. Lay-off is resorted to by the employer for factors beyond his control. Such factors could be:

- Fluctuations in the market resulting in loss of sales.
- Shortage of raw materials or power.
- Accumulation of stock.
- Breakdown of machinery.
- Production delays.

f) Golden Handshake

It is a method of retrenchment wherein the employees with a certain minimum service can opt for voluntary retirement and get a fat lumpsum in return. Golden handshake is usually offered by the Government to reduce the size of the bureaucracy and close down chronically loss-making public sector enterprises. Many thinkers on the subject are of the opinion that golden handshake is the fallout of the new economic policy followed by the Government of India. In the 1992–93 Union Budget, the Government had provided Rs. 450 crores for the Voluntary Retirement Scheme (VRS) for its employees.

(g) Retirement

In India, the retirement age is 58 or 60 years. Some employers may extend the age upward or downward from this base. For those employees who retire, it is a significant milestone. Regardless of the age at which retirement occurs, workers may need preparation through counselling. They should be informed about pension choices and insurance benefits after retirement. Employees at retiring age often feel they could continue to work effectively and there is a strong resistance from many to give up employment. For an organization, in times of staff shortage, retired employees are of great help.

5.6 Implication of Job change

Effects of Promotion:

A Promotion results in an employee taking on responsibility for managing or overseeing the work of other employees.

A Promotion is viewed as desirable by employees because of the impact a promotion has on

pay, authority, responsibility, and the ability to influence broader organizational decision making. It is a form of recognition for Employees who make significant and effective work contributions. An individual who receives a promotion normally receives additional financial rewards and the ego boost associated with achievement and accomplishment.

A promotion is a powerful communication tool about what is valued within an organization.

Effects of Demotion:

- Demotion sends a strong signal to the employee that his behavior is not acceptable to the organization.
- It can also have a demoralizing effect on other employees who happen to work with the demoted employee.
- Demotion will have a serious impact on need fulfillment.
- If demotion is chosen over termination, efforts must be made to preserve the self esteem of the individual. A positive image of the worker's value to the company should be projected.

5.7 THE EVALUATION AND CONTROL PROCESS

Ensure that a company is achieving what it set out to accomplish. It compares performance with desired result and provides the feedback necessary for management to evaluate results and take corrective action, as needed.

A Five Step Feedback Model:

Determine what to measure : Top managers and operational managers need to specify what implementation process and results must be capable of being measured in a reasonably objective and consistent manner. The focus should be on the most significant element in a process the ones that account for highest proportion of expense or the greatest number of problems. Measurement must be found for all important areas, regardless of difficulty.

Establish standards of performance: Standards used to performance are detailed expressions of strategic objectives they are measure of acceptable performance results. Each standard usually includes a tolerance range that defines acceptable deviation. Standards can be set not only for final output but also for intermediate stages of production output.

Measure performance : measurement must be made at predetermined times.

Compare actual performance with the standard: if actual performance results are within the desired tolerance range. The measurement process stop here.

Take corrective action: if actual results fall outside the desired tolerance range action must be taken to correct the deviation, the following questions must be answered:

1. Is the deviation only a chance fluctuation?
2. Are the process being carried out incorrectly?
3. Are the process appropriate to the achievement of the desired standard? Action must be taken will not only correct the deviation but also prevent it is happening again.
4. Who is the best person to take corrective action?

Measuring performance

The end result of activity. Which measures to select assess performance depends on the organizational unit to be appraised and the objective to be achieved. The objectives that were established earlier in the strategy formulation part of strategic management process (dealing with profitability, market share, and cost reduction, among others) should certainly be used to measure corporate performance once the strategies have been implemented.

5.8 GRIEVANCE:

It may be any genuine or imaginary feeling of dissatisfaction or injustice which an employee experiences about his job and its nature, about the management policies and procedures. It must be expressed by the employee and brought to the notice of the management and the organization. Grievances take the form of collective disputes when they are not resolved. Also they will then lower the morale and efficiency of the employees. Unattended grievances result in frustration, dissatisfaction, low productivity, lack of interest in work, absenteeism, etc. In short, grievance arises when employees' expectations are not fulfilled from the organization as a result of which a feeling of discontentment and dissatisfaction arises. This dissatisfaction must crop up from employment issues and not from personal issues.

5.8.1 Grievance may result from the following factors-

- a. Improper working conditions such as strict production standards, unsafe workplace, bad relation with managers, etc.
- b. Irrational management policies such as overtime, transfers, demotions, inappropriate salary structure, etc.
- c. Violation of organizational rules and practices

The manager should immediately identify all grievances and must take appropriate steps to eliminate the causes of such grievances so that the employees remain loyal and committed to their work. Effective grievance management is an essential part of personnel management. The managers should adopt the following approach to **manage grievance effectively-**

1. **Quick action-** As soon as the grievance arises, it should be identified and resolved. Training must be given to the managers to effectively and timely manage a grievance. This will lower the detrimental effects of grievance on the employees and their performance.
2. **Acknowledging grievance-** The manager must acknowledge the grievance put forward by the employee as manifestation of true and real feelings of the employees. Acknowledgement by the manager implies that the manager is eager to look into the complaint impartially and without any bias. This will create a conducive work environment with instances of grievance reduced.
3. **Gathering facts-** The managers should gather appropriate and sufficient facts explaining the grievance's nature. A record of such facts must be maintained so that these can be used in later stage of grievance redressal.
4. **Examining the causes of grievance-** The actual cause of grievance should be identified. Accordingly remedial actions should be taken to prevent repetition of the grievance.
5. **Decisioning-** After identifying the causes of grievance, alternative course of actions should be thought of to manage the grievance. The effect of each course of action on the existing and future management policies and procedure should be analyzed and accordingly decision should be taken by the manager.
6. **Execution and review-** The manager should execute the decision quickly, ignoring the fact, that it may or may not hurt the employees concerned. After implementing the decision, a follow-up must be there to ensure that the grievance has been resolved completely and adequately.

An effective grievance procedure ensures an amiable work environment because it redresses the grievance to mutual satisfaction of both the employees and the managers. It also helps the management to frame policies and procedures acceptable to the employees. It becomes an effective medium for the employees to express their feelings, discontent and dissatisfaction openly and formally.

5.8.2 Objectives of Grievance Handling Procedure:

Objectives of the grievance handling procedure are as follows:

1. To enable the employee to air their grievance
2. To clarify the nature of the grievance
3. To investigate the reasons for dissatisfaction
4. To obtain, where possible, a speedy resolution to the problem
5. To take appropriate actions and ensure that promises are kept
6. To inform the employee of their right to take the grievance to the next stage of the procedure, in the event of an unsuccessful resolution

5.8.3 Benefits of Grievance Handling Procedure:

Benefits that accrue to both the employer and employees are as follows:

1. It encourages employees to raise concerns without fear of reprisal.
2. It provides a fair and speedy means of dealing with complaints.
3. It prevents minor disagreements developing into more serious disputes.
4. It serves as an outlet for employee frustrations and discontents.
5. It saves employer's time and money as solutions are found for workplace problems. It helps to build an organizational climate based on openness and trust.

Details of a grievance procedure/machinery may vary from organization to organization.

5.8.4 The four stages of the machinery are briefly discussed here:

1. Initial level at which grievance occurs:

The greatest opportunity to redress a grievance is to resolve it at the initial level at which it occurs. A worker's grievance should be resolved by their immediate boss, the first-line supervisor. The first stage of the procedure usually involves three persons—the aggrieved employee, his immediate boss and the union representative.

It is possible to involve the union in laying down the framework of the grievance procedure and thereafter restrain union involvement in the actual process, at least in the first two stages.

Supervisory role needs to be strengthened, with appropriate training in problem-solving skills, grievance handling, and counselling.

2. Intermediate stage:

If the dispute is not redressed at the initial state at supervisor's level, it is usually referred to the head of the concerned department. It is important that the management assumes prime responsibility for the settlement of a grievance. At the intermediate level, grievance can be settled with or without union involvement.

3. Organization level:

If a grievance is not settled at the intermediate level also, it can be referred to the top management. Usually, a person of a level not less than the general manager designated for the purpose directly handles the issue. At this level, it is very difficult to reconcile the conflicting interests.

4. Third-party mediation:

If the grievance has not been settled bilaterally within the organization, it goes to a third party for mediation. Arbitration or adjudication or the matter may even be referred to a labour court. At this stage, the parties concerned lose control over the way the grievance is settled.

In case of mediation (conciliation or arbitration), the mediator has no authority to decide, but in case of the labour court or an adjudicator, the decision will be binding on the parties, subject to statutory provisions for appeal to higher courts.

At any stage of the grievance machinery, the dispute must be handled by some members of the management. In grievance redressal, responsibility lies largely with the management. And, as already discussed, grievances should be settled promptly at the first stage itself.

5.8.5 Methods of Identifying Grievances

The following methods can help the employer to identify the grievances:

1. Directive observation:

Knowledge of human behaviour is requisite quality of every good manager. From the changed behaviour of employees, he should be able to snuff the causes of grievances. This he can do without its knowledge to the employee. This method will give general pattern of grievances. In addition to normal routine, periodic interviews with the employees, group meetings and collective bargaining are the specific occasions where direct observation can help in unfolding the grievances.

2. Grip boxes:

The boxes (like suggestion boxes) are placed at easily accessible spots to most employees in the organisation. The employees can file anonymous complaints about their dissatisfaction in these boxes. Due to anonymity, the fear of managerial action is avoided. Moreover management's interest is also limited to the free and fair views of employees.

3. Open door policy:

Most democratic by nature, the policy is preached most but practiced very rarely in Indian organizations. But this method will be more useful in absence of an effective grievance procedure, otherwise the organisation will do well to have a grievance procedure. Open door policy demands that the employees, even at the lowest rank, should have easy access to the chief executive to get his grievances redressed.

4. Exit interview:

Higher employee turnover is a problem of every organisation. Employees leave the organisation either due to dissatisfaction or for better prospects. Exit interviews may be conducted to know the reasons for leaving the job. Properly conducted exit interviews can provide significant information about the strengths and weaknesses of the organisation and can pave way for further improving the management policies for its labour force.

5.8.6 The following steps provide a measure of guidance to the manager dealing with grievances:

1. Acknowledge dissatisfaction:

Managerial/supervisory attitude to grievances is important. They should focus attention on grievances, and not turn away from them. Ignorance is not bliss; it is the bane of industrial conflict. Arrogant attitude on the part of supervisors and managers aggravates the problem.

2. Define the problem:

Instead of trying to deal with a vague feeling of discontent, the problem should be defined properly. Sometime the wrong complaint is given. By effective listening, one can make sure that a true complaint is voiced.

3. Get the facts:

Facts should be separated from fiction. Although grievances result in hurt feelings, the effort should be to get the facts behind the feelings. There is need for a proper record of each grievance.

4. Analyse and decide:

Decisions on each grievance will have a precedent effect. While no time should be lost in dealing with them, it is no excuse to be slipshod about it. Grievance settlements provide opportunities for managements to correct themselves, and thereby come closer to the employees. Horse-trading in grievance redressal due to union pressures may temporarily bring union leadership closer to the management, but it will surely alienate the workforce away from the management.

5. Follow up:

Decisions taken must be followed up earnestly. They should be promptly communicated to the concerned employee. If a decision is favourable to the employee, their immediate boss should have the privilege of communicating the same.

HUMAN RESOURCE MANAGEMENT**Question Bank****Part A**

1. Define HRM. How does it differ from Personnel Management?
2. Explain the objectives of HRM. How can these objectives be achieved?
3. Discuss the functions of Human Resource
4. Discuss the qualities & qualification of HR Manager
5. Discuss the various advantages and uses of Human Resource Information System.
6. Define Trade Union. Why do employees join unions?
7. Define Human Resource Planning. Explain the importance of Human Resource Planning
8. What the levels of Human Resource Planning?
9. What are the objectives of Human Resources Planning?
10. Define Recruitment. Bring out the factor influences of recruitment.
11. What are the various sources of recruitment. Discuss their relative merits and demerits.
12. Define Selection. Discuss various types of employment test.
13. What are the uses of job analysis?
14. What is job description? What are the contents of job description?
15. What is job specification? What the uses of job specification?
16. What are the contents of job specification?
17. What is job design? Bring out the factors that affect job design.
18. What is job rotation? State their uses.
19. What is job enrichment? Discuss the need for job enrichment.
20. Define job enlargement? State their uses.
21. What is job evaluation? What are the objectives of job evaluation?
22. Discuss the advantages and disadvantages of job evaluation.
23. What do you mean by training? Distinguish between training, development and education.
24. What are the objectives of training? Explain the need for training in organization.
25. What are the benefits of training?
26. Explain the methods of assessing training needs.
27. What is knowledge management? What are the benefits of Knowledge Management?
28. Distinguish between Promotion and Transfer
29. Distinguish between Dismissal and Retrenchment
30. What do you meant by compensation? What are the basic objectives and principles of wages & salary administration?
31. Distinguish between wage and salary
32. What are compensation incentives?

33. Give a note on wage differentials.
34. What are the various types of rewards?
35. What are the various fringe benefits offered to employees?
36. What is meant by Career? Outline the process of Career Planning clearly.
37. Is career planning is important? Why?
38. What is Performance Appraisal? What are the needs of Performance Appraisal?
39. What are objectives of Performance Appraisal?
40. What is the importance of Performance Appraisal?
41. Define Quality Control. What are the features of Quality Control?
42. Explain how to develop quality control in organization.
43. What are the problems in quality control?
44. Write a note on occupational hazards?
45. Outline the causes of industrial accidents. How can accidents be avoided?
46. What is stress Management? What are causes of stress?
47. Define the term Personnel Research? Also appreciate the need for it.
48. What is Personnel Audit? List its objectives & outline its scope also.
49. What is Time Management? What are the uses of Time Management?
50. What is Human Resource Accounting? What are the advantages of Human Resource Accounting?

Part B

1. Describe the importance of Human Resource Management.
2. Describe the role of Human Resource Manager in detail.
3. Explain Human Resource Information System.
4. Explain the role of trade union.
5. Explain the steps in Human Resource Planning.
6. Explain the recruitment process
7. Write a note on recruitment practices followed in Indian organization both in public and private sectors.
8. Explain the steps involved in selection procedure (Selection Process)
9. Write a note on
 - ** Psychological Test
 - ** Stress Interview
 - ** Application Blank
 - ** Personality Test
 - ** Reference Check
10. Selection is virtually a kind of elimination process. Comment
11. What is interview? Explain the different types of interview.

12. Briefly describe the concept of job analysis & explain the job analysis process
13. Briefly explain the various methods of job evaluation
14. Explain the training procedure in detail
15. Explain the various training methods in detail
16. What is Management Development Programme or Executive Development Programme? What are the different MDP methods?
17. Can training be evaluated? Why? How?
18. Training Programmes are helpful to avoid personnel obsolescence. Discuss.
19. You cannot develop managers. People either have the ability to manage or they don't. Do you agree or disagree? Discuss.

Reg. No. :

--	--	--	--	--	--	--	--	--	--	--	--	--	--	--	--	--	--	--	--

Question Paper Code : 60312

M.B.A. DEGREE EXAMINATION, MAY/JUNE 2014.

Second Semester

BA 7204 – HUMAN RESOURCE MANAGEMENT

(Regulation 2013)

Time : Three hours

Maximum : 100 marks

Answer ALL questions.

PART A — (10 × 2 = 20 marks)

1. Differentiate HRM and HRD.
2. Define human resource audit.
3. Why human resource planning is important?
4. What is Induction Programme?
5. Write a short note on simulated training.
6. Define knowledge management.
7. Define compensation management.
8. What are the stages in career development?
9. Define Behaviourally Anchored Rating Scales.
10. Define Halo error effect.

PART B — (5 × 16 = 80 marks)

11. (a) Explain the various phases in evolution of human resource management.

Or

- (b) Explain human resource management and how it relates to the management process.

12. (a) What is recruitment? What are the various internal and external sources of recruitment?

Or

- (b) Discuss in detail the steps involved in the Selection Process.

13. (a) What are the various types of on - the - job training methods? Explain them.

Or

- (b) Explain the process of executive development programmes.

14. (a) Define motivation. Explain any two theories of motivation.

Or

- (b) What are the factors deciding compensation of employee? Explain in detail.

15. (a) Discuss various techniques used to evaluate employees performance.

Or

- (b) What are the sources of grievances? Explain the grievance handling procedure.

Reg. No. :

--	--	--	--	--	--	--	--	--	--	--	--	--	--	--	--	--	--	--	--

Question Paper Code : 96010

M.B.A. DEGREE EXAMINATION, FEBRUARY/MARCH 2014.

Second Semester

DBA 1653 — HUMAN RESOURCE MANAGEMENT

(Regulations 2007/2009)

Time : Three hours

Maximum : 100 marks

Answer ALL questions.

PART A — (10 × 2 = 20 marks)

1. What are the qualities that a HR Manager should possess in order to perform his job effectively?
2. What are the various environmental factors which affect HR Management Practices?
3. What is meant by human resource planning?
4. Write short note on Thematic Appreciation Test?
5. Briefly explain the two types of knowledge.
6. What do you mean by Executive Development Programme?
7. What is career management?
8. What is meant by morale?
9. What is meant by promotion?
10. What do you mean by grievance redressal procedure?

PART B — (5 × 16 = 80 marks)

11. (a) "Human resource management practices are culture bound". Discuss this statement and show how different cultures adopt different human resource management practices?

Or

- (b) "Human resource policies are guidepost to human resource management function". Explain this statement.

12. (a) Why has there been an increased emphasis on human resource planning? Illustrate with examples the process of human resource planning at enterprise level.

Or

- (b) Discuss the steps involved in recruitment process? How will you reconcile the internal and external sources of recruitment?

13. (a) How will you identify the training needs of an manufacturing organization? Explain few important training methods.

Or

- (b) How will you evaluate the effectiveness of an executive development programme? If it is not effective, what steps will you take to make it effective?

14. (a) What is compensation plan? Discuss the factors that should be taken into consideration while formulating an effective compensation plan.

Or

- (b) "Money cannot motivate all people under all circumstances". Discuss.

15. (a) What do you meant by 360 degree appraisal? What are the relative merits and demerits of 360 degree appraisal?

Or

- (b) What are the causes of employee grievences in an organization? How can such grievences be addressed effectively?

Reg. No.

--	--	--	--	--	--	--	--	--	--	--	--	--	--	--	--	--	--	--	--

Question Paper Code : 86010

M.B.A. DEGREE EXAMINATION, AUGUST 2013.

Second Semester

DBA 1653 — HUMAN RESOURCE MANAGEMENT

(Regulation 2007/2009)

Time : Three hours

Maximum : 100 marks

Answer ALL questions.

PART A — (10 × 2 = 20 marks)

1. Explain the objectives of human resource management.
2. "Human resource is old wine in the new bottle" – comment.
3. How is demand for human resource forecast?
4. What are the socialization benefits of HRM?
5. Explain the need for employee training.
6. Define knowledge management.
7. What are the types of reward?
8. Explain the components of remuneration.
9. State the meaning of promotion and its policy.
10. Define feedback interview.

PART B — (5 × 16 = 80 marks)

11. (a) Discuss the role and functions of Human Resource Management.

Or

- (b) What are the policies are adopted in Human Resource Management?

12. (a) Discuss the problems faced in human resource planning .How can these problems can be over come?

Or

- (b) Explain the various stages involved in the selection of candidates for jobs in an organisation.

13. (a) Briefly discuss the steps involved in conducting a training programme in a systematic way.

Or

- (b) Explain Executive development programme. Discuss its suitability in developing middle level managers.

14. (a) What is career delvopment? Explain the stages involved in it.

Or

- (b) Briefly discuss the functions and responsibilities of mentoring.

15. (a) What do you mean by performance appraisal? Discuss the need for performance appraisal.

Or

- (b) Give an account of the complaints and grievances practices followed in Industry.

Reg. No. :

--	--	--	--	--	--	--	--	--	--	--	--	--	--	--	--	--	--	--	--

Question Paper Code : 75510

M.B.A. DEGREE EXAMINATION, AUGUST 2012.

Second Semester

DBA 1653 – HUMAN RESOURCE MANAGEMENT

(Regulation 2007/2009)

Time : Three hours

Maximum : 100 marks

Answer ALL questions.

PART A — (10 × 2 = 20 marks)

1. Define HRM.
2. Define HR policies.
3. What is recruitment?
4. Define skill Inventories.
5. Define reinforcement.
6. Define executive development.
7. What is morale?
8. Define career anchor.
9. Define whistle blowing.
10. State the types of transfer.

PART B — (5 × 16 = 80 marks)

11. (a) Describe the evolution of HRM in Indian scenario.

Or

- (b) Why it is important for HR management to evolve from an administrative and operational level to a strategic level?

12. (a) Define HRP planning. Describe its characteristics and objectives. Explain the reasons for the growing interest in HRP in recent years.

Or

- (b) If you were responsible for hiring someone for your job, which recruitment sources would you use? Why? Which recruitment sources would you avoid? Why?
13. (a) Briefly outline the steps involved in conducting a training programme in a systematic way.

Or

- (b) What do you mean by executive development? Discuss the methods of executive development.
14. (a) Write a note on different stages in the career and list out the career development strategies followed by the any five Indian companies.

Or

- (b) What do you mean by fringe benefits? Explain the need for fringe benefits. Explain the various types of fringe benefits offered to employees in India.
15. (a) Explain the individual performance appraisal methods.

Or

- (b) Discuss the model grievance procedure that is applicable in India. What are the essential prerequisites of a grievance procedure?

Reg. No. :

--	--	--	--	--	--	--	--	--	--	--	--	--	--	--	--	--	--	--	--

Question Paper Code : 85510

M.B.A. DEGREE EXAMINATION, FEBRUARY 2012.

Second Semester

DBA 1653 — HUMAN RESOURCE MANAGEMENT

(Regulation 2007/2009)

Time : Three hours

Maximum : 100 marks

Answer ALL questions.

PART A — (10 × 2 = 20 marks)

1. Differentiate personnel management and HRM.
2. Mention the major objectives of HRM.
3. What are the prerequisites for conducting tests for selection?
4. Specify the advantages of HRP.
5. Define knowledge workers.
6. Specify the purpose of on-the job training.
7. Define motivation.
8. What do you mean by career path?
9. Name the activities based on performance appraisal.
10. Define grievance.

PART B — (5 × 16 = 80 marks)

11. (a) (i) Elaborate the evolution of HRM. (8)
- (ii) Explain the position of HR department in an organisation. (8)

Or

- (b) Elaborate the roles of HR manager.

12. (a) Explain the process of human resource planning.

Or

(b) Discuss the sources of recruitment mainly adopted by MNCs today.

13. (a) List and explain the steps in management development programme. Also explain any two methods of EDP.

Or

(b) Elaborate the subsystems in HRD mechanisms.

14. (a) Discuss various tools for career development. Also differentiate career planning and succession planning.

Or

(b) Elaborate achievement motivation theory and its implication.

15. (a) Explain the process of performance appraisal and explain any two modern techniques.

Or

(b) "Collective bargaining is an effective tool for grievance redressal". Explain the process of collective bargaining.

12. (a) What are the major reasons for the emphasis on HRP at the macro level and explain any two techniques of HR demand forecasting?

Or

- (b) Why do organizations prefer internal source? Explain the advantages and disadvantages of internal recruiting?

13. (a) Explain the principles, needs, criteria and levels of training evaluation.

Or

- (b) Explain the process of executive development with illustrations.

14. (a) What is ERG theory of motivation? Discuss its merits and limitations.

Or

- (b) Define the terms career planning and career development. Explain career development initiatives.

15. (a) Explain the process of performance appraisal.

Or

- (b) Explain in brief about different separation modes and their policies.

Reg. No. :

--	--	--	--	--	--	--	--	--	--	--	--	--	--	--	--	--	--	--	--

Question Paper Code : 85510

M.B.A. DEGREE EXAMINATION, FEBRUARY 2011.

Second Semester

DBA 1653 — HUMAN RESOURCE MANAGEMENT

(Regulation 2007/2009)

Time : Three hours

Maximum : 100 marks

Answer ALL questions.

PART A — (10 × 2 = 20 marks)

1. Explain the importance of Human Resource Management in the globalised era.
2. "The role of human resource manager has increased" – Explain.
3. What is the importance of HRP?
4. What are the benefits of socialization?
5. What are the methods of training?
6. What is the importance of knowledge management?
7. What is career planning?
8. Explain the role of mentor.
9. What are the reasons for demotion?
10. List down any four grievances that can become disputes.

PART B — (5 × 16 = 80 marks)

11. (a) What are the challenges of HRM in the global environment?
- Or
- (b) Explain computer applications in HRM.
12. (a) What are the techniques of forecasting human resources of an organisation?
- Or
- (b) Discuss the recruitment and selection process for any four designations of a manufacturing company of your choice.
13. (a) Explain the objectives and methods of training of supervisions in organisations.
- Or
- (b) Discuss the role and types of executive development programmes.
14. (a) Explain Maslow's theory of motivation and its suitability for multinational organisations.
- Or
- (b) Discuss transfers and separation processes of any organisation.
15. (a) Explain methods of performance appraisal systems.
- Or
- (b) How to retain and control people in the organisation?
-

Reg. No. :

--	--	--	--	--	--	--	--	--	--

Question Paper Code : GG 1510

M.B.A. DEGREE EXAMINATION, AUGUST 2010.

Second Semester

DBA 1653 — HUMAN RESOURCE MANAGEMENT

(Regulation 2007/2009)

Time : Three hours

Maximum : 100 marks

Answer ALL questions.

PART A — (10 × 2 = 20 marks)

1. Explain the need for HRM.
2. What is Human resource management?
3. What is organizational culture?
4. Define strategic HRM.
5. Explain job analysis.
6. What are the problems in job analysis?
7. What is Dejobbing?
8. Explain the concept of recruitment.
9. What is induction program?
10. Explain the term Halo Error.

PART B — (5 × 16 = 80 marks)

11. (a) What are the factors influencing wage and salary administration?

Or

(b) Explain the process of job evaluation.

12. (a) Briefly explain the agencies of labour welfare in India.

Or

(b) What are the causes for poor industrial relations?

13. (a) Describe the essentials of a good incentive plan.

Or

(b) Explain the traditional methods of performance appraisal.

14. (a) Explain the factors of individual career planning.

Or

(b) Explain the need and importance of training.

15. (a) Explain the process of training.

Or

(b) Explain the characteristics of a good test.

Reg. No. :

--	--	--	--	--	--	--	--	--	--	--	--	--	--	--	--	--	--	--	--

Question Paper Code : YY 1510

M.B.A. DEGREE EXAMINATION, FEBRUARY 2010.

Second Semester

DBA 1653 — HUMAN RESOURCE MANAGEMENT

(Regulation 2007)

Time : Three hours

Maximum : 100 marks

Answer ALL questions.

PART A — (10 × 2 = 20 marks)

1. What is HRM? Is it same as Personnel Management?
2. What are the objectives of HRM?
3. What is the meaning of human resource planning?
4. Give two important reasons for forecasting human resource requirement.
5. List two benefits of training.
6. What is the need for executive development?
7. What is motivation? Why is it a critical issue of interest to managers in organizations?
8. How is job enrichment different from job enlargement?
9. What is peer evaluation?
10. What are the possible significant implications of a job change?

PART B — (5 × 16 = 80 marks)

11. (a) What is the role of an HR manager in an organization, and what are the desirable qualities in HR manager? Explain.

Or

- (b) Discuss the need and role of computers in HR management.

12. (a) Why should organizations engage in HR planning? Why do some organizations require relatively complex and comprehensive HR planning systems than do others? Discuss.

Or

- (b) Define 'recruitment'. List the methods of recruitment and explain them.
13. (a) Describe any four methods/ techniques each of on-the-job and off-the-job type of training. Also list their merits and demerits.

Or

- (b) What are the objectives of Executive Development Programmes (EDP)? Describe the methods of EDP.
14. (a) Discuss any four relevant theories of motivation and highlight their unique contributions to HR management.

Or

- (b) What is understood by the term 'career'? Why should an employee plan for it? Why should organizations become involved in career planning with their employees? Discuss the steps in career planning.
15. (a) With reference to performance appraisal/assessment, explain the following with the help of suitable example(s)
- (i) BARS
 - (ii) Behavioural Observation Scales (BOS)
 - (iii) Management by Objectives (MBO)
 - (iv) 360-degree appraisal.

Or

- (b) What is a grievance? Why do organizations need a grievance redressal procedure? What are the elements of grievance redressal procedure? Discuss the grievance handling procedure in a typical organization.